

SP-2000

User & Service

Manual

SP SERIES
CONTINUOUS POWER SYSTEM

MODELS COVERED:

SP2000SR

SP2000SN

Included with:

PIM30 & PIM60

2000VA

CLARY CORPORATION

150 E. Huntington Drive
Monrovia, California 91016

Telephone ☎ 626-359-4486

☎ 800-44 CLARY

Fax. ☎ 626-305-0254

World Wide Web 🌐 [HTTP://WWW.CLARY.COM](http://WWW.CLARY.COM)

E-Mail 📧 SALES@CLARY.COM

Information contained herein is the property of Clary Corporation, is proprietary, confidential, and not to be disclosed, disseminated or used except for the purpose provided by
CLARY CORPORATION

TABLE OF CONTENTS

Section 1 General Description

1.1 Introduction 5
1.2 Operating Modes..... 6
1.3 Physical Description..... 8

Section 2 General Characteristics

2.1 General Characteristics..... 13
2.2 Specification..... 16

Section 3 Installation and Operations

3.1 Installation 19
3.2 Preparation..... 19
3.3 Procedure..... 21
3.4 Operation Configuration and Setup..... 22
3.5 PIM: Summary of Connectors..... 23
3.6 Operation 25
3.7 Optional Communication Procedure 26

Section 4 Adjustments

4.1 Adjustment Overview for DOS Programs..... 28
4.2 Adjustment Overview for Windows Programs..... 33

Section 5 Care and Maintenance

5.1 Safety 40
5.2 Preventive Maintenance..... 41
5.3 Trouble Analysis..... 42
5.4 Service and Repair..... 43

Warranty..... 44

LIST OF FIGURES

Figure 1	Front Panel View	8
Figure 2	Rear Panel View	10
Figure 3	PIM To Cabinet Interconnections	22
Figure 4	PIM30 & PIM60-Front View	23
Figure 5	PIM30 Simplified Schematic Diagram	24
Figure 6	PIM60 Simplified Schematic Diagram	24
Figure 7	Signal/RS232 Pin Assignments	27

LIST OF TABLES

Table 1	Front Panel View.....	9
Table 2	Rear Panel View	10
Table 3	Electrical Specifications	16
Table 4	Physical Specifications, UPS Electronics Module.....	17
Table 5	Physical Specification, PIM Module	17
Table 6	Environmental Specifications.....	17
Table 7	Battery Specifications	17
Table 8	Clary OutPost™ Batteries*	18
Table 9	Recommended Installation Equipment	20
Table 10	Installation Procedure For Traffic UPS	21
Table 11	Preventive Maintenance Schedule	42

“IMPORTANT SAFETY INSTRUCTIONS” “SAVE THESE INSTRUCTIONS”

This manual contains important safety instructions that should be followed during installation and maintenance of the UPS and batteries. The instructions should be followed during installation and maintenance of the UPS and batteries. Be aware of the following symbols and their meaning as they appear throughout the manual:

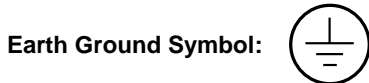
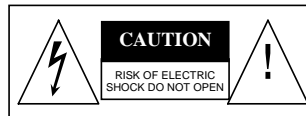
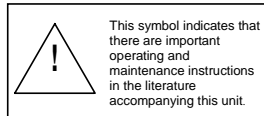
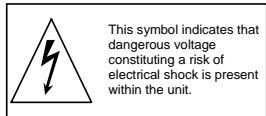

Internal Battery Voltage is 96 VDC.

Maximum Ambient Temperature 74° C.

This unit intended for installation in a controlled environment (temperature controlled, indoor area free of conductive contaminants).

CAUTION – Do not dispose of batteries in a fire. The batteries may explode.

CAUTION - Do not open or mutilate the batteries. Released electrolyte is harmful to the skin and eyes. It may be toxic.

CAUTION - A battery can present a risk of electrical shock and high short circuit current. The following precautions should be observed when working on batteries.

1. Remove watches, rings, or other metal objects.
2. Use tools with insulated handles.

FCC-Rules

This equipment generates and uses radio frequency energy and if not installed and used properly in strict accordance with the manufacturer's instructions, may cause interference to radio and television reception. All units in this manual have been tested and found to comply with the limits for a Class A computing device in accordance with the specifications in Subpart J of Part 15 of FCC Rules, which are designed to provide reasonable protection against such interference in a commercial installation. However, there is no guarantee that interference will not occur in a particular installation. If this equipment does cause interference to radio and television reception, which can be determined by turning the equipment off and on, the user is encouraged to try to correct the interference by one or more of the following measures:

- ☐ Reorient the receiving antenna.
- ☐ Relocate the UPS with respect to the receiver.
- ☐ Move the UPS away from the receiver.
- ☐ Plug the UPS into a different outlet so that the UPS and receiver are on different branch circuits.

If necessary, the user should consult the dealer or an experienced radio/television technician for additional suggestions. The user may find the following booklet prepared by the Federal Communications Commission helpful:

"How To Identify and Resolve Radio-TV Interference Problems"

This booklet is available from the U.S. Government Printing Office, Washington, DC 20402, Stock No. 004000003454.

Section 1

GENERAL DESCRIPTION

1.1 INTRODUCTION

You have selected the highest quality power protection system available for your traffic control devices. You now own a SP Series Traffic UPS (Uninterruptible Power System). The SP Series is an all *Digital Technology* UPS product designed and manufactured by Clary Corporation, the first name in UPS reliability. Clary UPS can be found on naval warships and submarines, hospital operating rooms, labs, water treatment plants and traffic intersections. The *SP (Signal Power) Series* offers a rugged, compact package with superior features and performance you can depend on.

When power problems occur, there can be no compromising the operations and reliability of your traffic control devices - - and no compromising public safety. With fully conditioned, regenerative, sine wave power and military-quality battery backup, the SP Series Traffic UPS is your complete power solution.

This Owner's Operating Manual is provided with your new SP Series Traffic UPS. It will enhance your understanding of the product and its functions.

WE STRONGLY URGE YOU TO READ THIS MANUAL COMPLETELY, PRIOR TO BEGINNING INSTALLATION OR ATTEMPTING OPERATION.

Studying this manual will save you time and effort in your installation and application, and it will assure a trouble free installation and startup session, thus enhancing public safety and the image of your agency.

The illustrations provided will familiarize you with this product's operating modes and components. Always operate the unit within the guidelines and specifications provided to maximize safety and the lifetime of the unit. Your understanding of the product is a key element in assuring the proper use and effectiveness of the SP Series Traffic UPS.

1.2 OPERATING MODES

Clary's SP Series Uninterruptible Power Systems (UPS) are designed for powering traffic & pedestrian indications, plus critical traffic control devices (i.e., controllers, modems, CMU's, etc.). The power system consists of three elements, which work together to provide critical loads with continuous, conditioned, regulated, sinusoidal waveform power that is free from disturbances such as spikes, surges, brownouts or blackouts. These elements are the:

1. *UPS Module – (UPS)*
2. *Power Interface Module - (PIM)*
3. *Battery Module*

Backup power is achieved with a set of rechargeable, SVRLA (sealed valve-regulated lead-acid), maintenance-free, AGM (absorbed glass mat), batteries. The complete UPS system is controlled by an onboard digital microprocessor at all times.

There are two basic modes of operation:

- *Standby Operating Mode*
- *Continuous Operating Mode*

In both modes, the UPS continuously generates 120V AC power. The selected mode determines when and how the UPS generated power is applied to the loads in the traffic cabinet.

Standby Operating Mode:

During *Standby* operation, utility (AC) power enters the PIM and passes through a normally closed contactor then directly out to the cabinet power bus, PDA, etc. This utility power is used to power the intersection until a power disturbance occurs at which time, the contactor is switched, routing the UPS generated AC power to the cabinet power bus. Typically, the UPS will then be drawing its power from the battery pack. This operation continues until good utility power is restored, after which, the contactors switch back to route the utility power to the loads.

With *Standby* operation, 0.5 seconds (user programmable from 30ms to 2.5sec) after an outage is detected, standby power is connected to the system and if desired, the Flash Command is initiated, forcing the cabinet into *Flash Mode* operation. Depending on the size of the battery system being used and the loading on the power system, backup power can continue for several hours. **Note: If Flash Mode operation is not desired, make sure intersection Load is not over 1400 Watts.**

When utility power returns, (or upon application of generator power) the SP Series UPS waits 30 seconds to be sure that the utility power has stabilized. After this built-in safety delay utility power is restored to the cabinet. The battery charger then recharges the

batteries in typically 10 to 20 times (depending on the load) the duration of the outage or battery discharge time (whichever is shorter).

The UPS can be set to force a break in power of 2.5 seconds after utility power returns. This is optional (not the default) and is used in intersections when a hard-restart needs to be applied to various devices when returning from flash.

With *Standby* operation, the ONLY required change to cabinet wiring occurs by the introduction of the PIM. Removal and Replacement (R&R) of the UPS module is quick and easy even with traffic control devices (TCD's) connected to the UPS. If no TCD's are plugged into the UPS module (i.e. being used for LED flash backup only), R&R of the UPS module (for upgrades or in the rare event of UPS failure) can be done without powering down the cabinet or otherwise affecting cabinet operation in any way.

Continuous Operating Mode:

Continuous operation is used for low power applications such as full LED intersections, power to the intersection is continuously conditioned and backed up by the UPS. Within the limitation of the battery capacity, virtually all brownout and power outages are eliminated. Continuous operation can be used as long as your load does not exceed 1400 Watts.

Additional Notes on Operating Modes:

- A generator can also be connected up and fed through the PIM to provide indefinite auxiliary backup of the intersection. (OPTIONAL)
- The SP Series Traffic UPS is designed for compatibility with, and complete transparency to, all traffic signal cabinet functions including police panel operation.

Flash Operating Modes:(For PIM 30 Model only)

The PIM includes three (3) sets of normally-open (NO) and normally-closed (NC) relay style contacts. The contacts are intended to connect to the Flash controllers or other devices in the traffic cabinet. The contacts are actuated at various times as a means of signaling these devices of important aspects of current operation. These three relay contact sets are labeled and switched as follows:

Labeled	Usage / Indication	Notes
On-Batt	UPS is operating from battery power.	When unit is in "Standby Operation".
Timer	UPS has been on battery longer than programmable threshold. Used as notice of shutdown coming from low-battery cutoff.	Default time period is 2 hours. Programmable from 1 to 255 minutes.
Low-Batt	UPS is operating from battery and the battery voltage has fallen below a programmable threshold. Used as notice of shutdown coming from low-battery cutoff.	Default voltage is 92V (about 40% capacity.)

1.3 PHYSICAL DESCRIPTION

This section will point out and illustrate the various indicators, functions and controls of the SP Series UPS. The important attributes of the SP Series unit are numbered to assist you in locating them on your machine and also to fully explain its function and how it relates to system operation.

Numbers on the drawing will correspond to the operating component's name at the bottom with a brief identification. In the next section, a complete explanation of all numbered items will be enhanced to ensure you have a full understanding of the operation of this system.

Visual indicators used on the front panel are long lasting, very efficient, light emitting diodes (LED). When operating the push-button switches, always hold the switch in for at least two seconds to insure function confirmation. This feature has been implemented into the system design to avoid inadvertent operation of any of the user-available functions.

Figure 1 is the front view of the model SP2000SN. Model SP2000SR is identical in operation; however, items 17 through 22 have been repositioned to the rear panel.

Table 1 describes item 1-22.

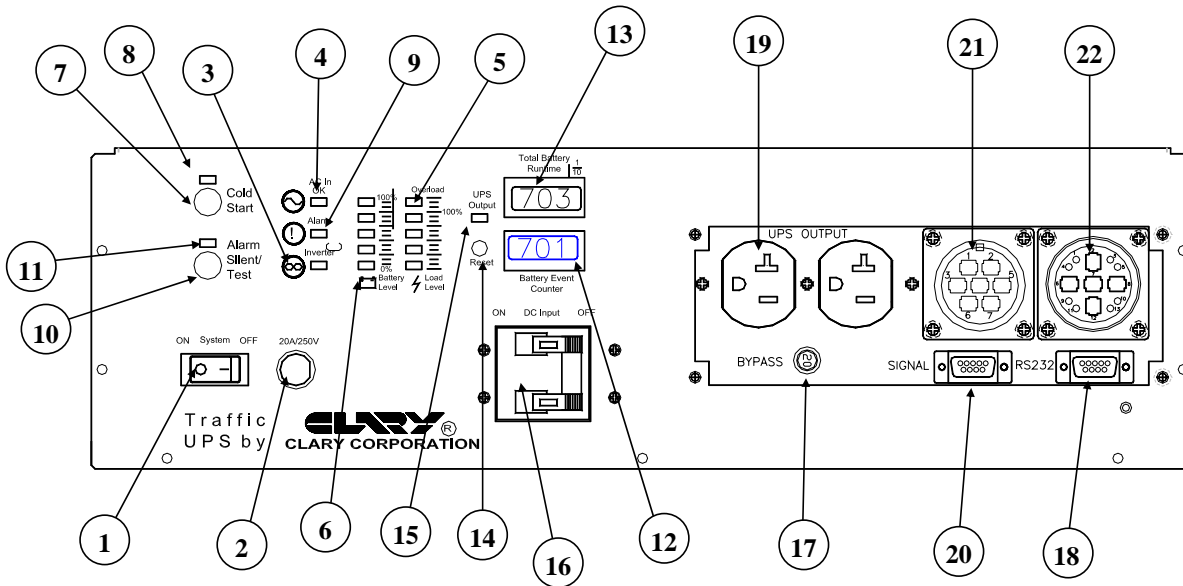

Formatted: Font: 11 pt, Not Bold

Formatted: Font: 11 pt, Not Bold

Figure 1: SP2000SN FRONT PANEL VIEW

Table 1: SP2000SN FRONT PANEL VIEW

SP2000SN FRONT PANEL VIEW			
1	SYSTEM POWER SWITCH	12	HOUR METER – Battery runtime meter in hours
2	INPUT AC LINE FUSE	13	EVENT COUNTER– Counts power interruptions
3	INVERTER – Inverter operating indicator	14	RESET – Clears Event Counter back to zero
4	AC IN – Input line indicator	15	UPS OUTPUT PRESENT – Output indicator
5	LOAD LEVEL – Output capacity indicators	16	DC INPUT– Protection circuit breaker for battery
6	BATTERY LEVEL -- Charge/discharge indicators	17	BYPASS – Protection circuit breaker for bypass
7	COLD START – DC start switch	18	RS232 – Computer communications signals
8	COLD START ACKNOWLEDGE INDICATOR	19	UPS OUTPUT – Continuous power receptacle
9	ALARM – Fault indicator	20	SIGNAL – Open-collector signal contacts
10	ALARM SILENT/TEST – Dual function switch	21	AC IN/OUT – Input receptacle for all AC power (To PIM)
11	ALARM SILENT/TEST ACKNOWLEDGE INDICATOR	22	DC IN – Input receptacle for all DC power (To Batteries)

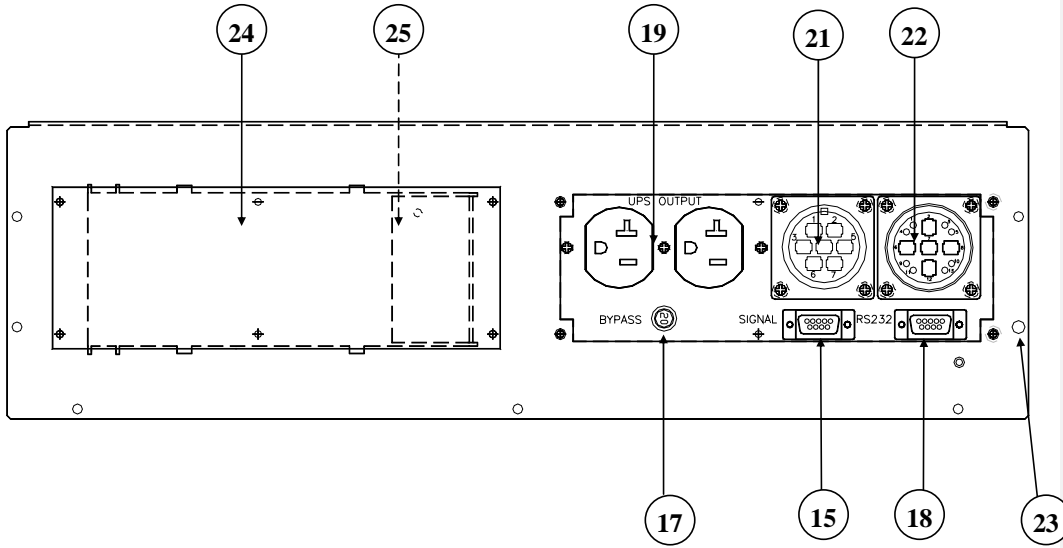

Figure 2: SP2000SR REAR PANEL VIEW

Table 2: SP2000SR REAR PANEL VIEW

SP2000SR REAR PANEL VIEW	
23	SYSTEM GROUNDING STUD
24	SNMP – (optional) Slot for sophisticated Network monitoring
25	FAST CHARGER MODULE (optional) Slot for extra charging module

SUMMARY OF INDICATORS AND CONTROLS

SYSTEM POWER SWITCH - The main control switch that engages utility power to the entire unit. By activating this switch it initializes normal operation.



NOTE – The DC INPUT circuit breaker must be “ON” before activating the System On/Off switch.

DC INPUT - A two pole, 30A circuit breaker used to connect the battery to the internal UPS electronics. It also protects against over-current situations in the battery circuit.

INPUT AC LINE FUSE - The input line protection device to limit excessive current draw to the system.

INVERTER - This indicator identifies the status of the regenerated, conditioned protected output power. This indicator will stay ON as long as protected power is available from the power inverter generator.

AC IN - The utility input indicator that identifies status of the line voltage. If the line voltage is within the specified range, it will remain lit. If the AC input is out of range, but present, the indicator will slowly blink.

LOAD LEVEL - This is the system output capacity status bar. The number of LEDS illuminated indicates an approximate percentage of system load. All green LEDS illuminated would indicate full load. The top red LED illuminates on over-loads.

BATTERY LEVEL - This is the battery status bar graph. During normal operation, this bar graph will show the charging of the battery; all indicators lit will represent a fully charged battery. During battery operation, this bar graph represents a discharge meter indicating less battery time available as each light goes OFF. If Battery status LEDS are blinking, the unit has failed a battery self test. See Trouble Analysis section on page 43 for more information.

COLD START - A momentary push-button switch to activate the system in the event no utility power is available. The system will be allowed to start up by using power from the battery. Depress this switch, the indicator above it will light, and hold it in until the audible alarm beeps once. The system will maintain a load for a period of time depending upon the condition of the battery. DC INPUT breaker must be ON.

ALARM - This is a fault indicator that will light in the event that the inverter generator is non-operable. This could be due to an over-temperature situation or an inverter malfunction.



NOTE - Cold Start and Alarm Silent switches must be held in for at least two seconds to engage their function. This is to prevent any inadvertent switch operation.

HOUR METER - A cumulative run time meter that shows the total battery run time for the life of the unit.

EVENT COUNTER - A meter that counts the number of times the system has gone into battery operation. The Event Counter also increments each time the unit is turned off and on by the SYSTEM POWER SWITCH.

RESET- A momentary pushbutton switch that resets the Event Counter to zero.

UPS OUTPUT PRESENT - A green LED that is illuminated to indicate fully conditioned and continuous output AC power is present at the output receptacle.

RS232 - A DB-9 subminiature, female connector that outputs true RS232 communications signals.

UPS OUTPUT - A NEMA type duplex, 5-20R output connector that provides continuous power. This receptacle is connected to the bypass line when the inverter is not running. NOTE: This output provides continuous UPS power even when UPS is in the offline mode. Do not load more than the rated output of the UPS(including what is already loaded through the PIM).

BYPASS - A 20A protective pop out circuit breaker in the bypass line of the continuous output circuit. Protects the UPS OUTPUT 5-20R connector noted above.

SIGNAL - A DB-9 subminiature, female connector that outputs the open-collector signal contacts that generate a low state during *utility interrupt*, *low battery* and *inverter off* conditions.

AC INPUT/OUTPUT- A circular locking connector provided for AC power from the PIM.

DC INPUT - A circular locking connector provided for battery power to the UPS.



NOTE – For safety purposes, these AC INPUT and DC INPUT connectors are tied into an interlock system which ensures that if either connector is disconnected, the unit will discontinue operation.

SYSTEM GROUNDING STUD - A 10-32 x 3/4 threaded stud for system grounding termination.

Section 2

GENERAL CHARACTERISTICS

2.1 CHARACTERISTICS

Overview

The Clary *SP Series* Traffic UPS is a turnkey, true on-line, power conditioner and battery backup or uninterruptible power system (UPS) designed for the extreme environments found in traffic cabinets (-40 to + 74 deg C).

The Clary *SP Series*, with its standard 41Ahr battery pack, is capable of operating, a full LED intersection for over an hour at 1400W (watts) output. A typical intersection consuming 450W can be powered for approximately 4 hours. In Red-Flash operation, which consume only about 300W, over 6 hours of backup is possible. These times assume fully charged batteries at an ambient temperature of 25C.

Operation

The Traffic UPS is capable of producing – simultaneously -- full regenerated and regulated, true sine wave power, with standby and continuous AC outputs. The Power Interface Module (PIM) is the link between the utility power, the UPS power, and the loads.

When utility power is adequate, the PIM routes that power to the loads. Upon loss of utility power the Traffic UPS routes UPS generated power to the loads. In the event of UPS failure and/or battery depletion, the PIM will ensure that the UPS will drop out and, return to utility power when available. The traffic control system will then default to normal operational mode.

The Power Interface Module (PIM) enables removal and replacement of the Traffic UPS without shutting down the traffic control system (i.e. “hot swap” capability). Connectors are equipped with a “safety interlock” feature.

For 170 type cabinets, upon loss of power the Traffic UPS can actuate the existing Flash Transfer Relays (FTRs), Mercury Contactor (MC) or Railroad Preemption to allow the traffic control system to put the cabinet into Flash Mode operation.

Existing Flasher Modules and Flash Transfer Relays are utilized. The Traffic UPS does not duplicate or take over flash operation or flash transfer relay functions.

The Traffic UPS is capable of providing continuous, fully regenerated, conditioned, regulated, sinusoidal (AC) power to selected devices such as signal controllers, counters, modems, communications hubs, NTCIP adapters, video equipment, etc.

To facilitate emergency crews and police activities, the Traffic UPS is compatible with police panel functions (i.e. "Signals OFF" switch must kill power to the field wiring even when on UPS/Battery power).

Utility Voltage Windows and Battery Operation

The UPS operates from utility if the utility voltage is between 85 and 135 vac. When the utility falls below 85 vac or climbs above 135 vac the UPS operates from the batteries. In the *Standby* modes of operation, the PIM is activated when the utility is below 100 +/- 2 VAC or above 130 +/-2 VAC.

There is a programmable noise rejection window, which specifies how the UPS system treats small time-duration power glitches. Power disturbances must last at least 40ms to trigger change in operation. Small disturbances on this order occur frequently due to many different conditions. These disturbances, however, are not detrimental to traffic controllers. To minimize nuisance switching this noise rejection window is implemented. See page 38 to Program this feature.

After operating in Standby mode, the UPS monitors the utility voltage. When this voltage is restored to adequate conditions for 30 seconds, the UPS returns utility power to the cabinet.

Description

The Traffic UPS consists of three major components, the UPS Power Module, the Power Interface Module, and the Battery System.

The UPS Power Module consists of the following:

- True on line, double conversion, pure sine wave, high frequency inverter utilizing IGBT technology.
- Local individual indicators for battery status, load level, battery run-time, and event counter.
- Two DB9F connectors for remote signal alarms, true RS232 monitoring and remote communications.
- Multi-stage, temperature compensated battery charger.

The Power Interface Module 30 contains a magnetic contactor for back feed protection and to facilitate hot swapping of the electronics module. It is the primary interface between the UPS and the cabinet.

The PIM houses the relays connected to the Flash controllers. These electro-mechanical relays are controlled by signals carried to the PIM from the UPS's SIGNAL port. These logic signals are converted through optical switches into 120VAC levels, which are then used to switch the electro-mechanical relays.

The Power Interface Module 60 contains two mercury contactors for back feed protection and to facilitate hot swapping of the electronics module. The PIM 60 does not include the electro-mechanical relays for the Low Battery and Timer function.

The Battery Module. The battery is comprised of one or more strings of 8 individual 12V batteries connected in series for a total string voltage of 96V DC nominal.

The batteries are extreme temperature, deep cycle, AGM/VRLA (Absorbed Glass Mat/ Valve Regulated Lead Acid) batteries that have been field proven and tested by the U.S. military. The OutPost™ batteries supplied by Clary Corporation are certified to operate at extreme temperatures from -40°C to +74°C.

The batteries are provided with appropriate interconnect wiring harness. Optional battery mounting trays and brackets are available.

The interconnect cable connects to the base module via a quick-release circular connector.

The UPS module includes a charger that replenishes the Battery Pack whenever possible and required. This charger operates with a maximum charging current of 0.6A at 96V. An optional "Fast Charger" module plugs into the UPS module to increase the charging current to over 3.5A at 96V.

Mounting/ Configuration

NEMA Style: mounting method is shelf-mount or wall-mount. 170 Style: Mounting method is 19" rack-mount. Shelf angles or rails, typically supplied by others, are available as optional accessories.

For purposes of safety and proper operation, the circular battery connector has interlocking pins to prevent turn-on if battery system is not connected, and to shut off the UPS should the battery system be disconnected.

Battery construction includes heavy-duty, inter-cell connections for low-impedance between cells, and heavy-duty plates to withstand shock and vibration.

2.2 SPECIFICATIONS

The various specifications of the UPS system are provided in the following tables.

Table 3: ELECTRICAL SPECIFICATIONS

Electrical Specifications	
Input Specification	
Nominal Input Voltage	120 VAC, Single Phase
Input Voltage Range	85 VAC to 135 VAC
Input Frequency	45 to 65 Hz (+/- 5%)
Input Configuration	3 Wire (Hot, Neutral & Ground)
Input Current (Max. draw)	14.3 amps, Power-Factor Corrected
Input Protection	Input Fuse (25 amps)
Output Specification	
Nominal Output Voltage	120 VAC, Single Phase
Power Rating	2 kVA (2000VA/1400W), 16.7Amps
Output Voltage Regulation	+/- 2% for 100% step load change and from High battery to Low battery condition
Output Frequency	50 or 60 Hz (+/- .5%) unit not in sync.
Output Configuration	Keyed, circular connectors and duplex Receptacle.
Output Wave Form	True Sine wave
Overload capability	110% for 10 minutes 200% for 50milliseconds
Fault clearing	Current limit and automatic shutdown
Short circuit protection	Current limit and automatic shutdown
Efficiency	90% at full load (on utility)
Load Power Factor	.7 lagging through unity to .7 leading

Table 4: PHYSICAL SPECIFICATIONS, UPS ELECTRONICS MODULE

Physical Specifications, UPS Electronics Module	
Dimensions:	
Rack-mount units:	Width = 19", Depth = 13", Height = 5.25" (3U)
Shelf-mount units:	Width = 19", Depth = 13", Height = 5.25"
Wall-mount: / Unistrut Rail mount units:	Width = 19", Depth = 13", Height = 5.25"
Weight:	UPS: 25 lbs., Shipping weight: 30 lbs.

Table 5: PHYSICAL SPECIFICATIONS, PIM MODULE

Physical Specifications, PIM Module	
Dimensions:	
	Width = 6", Depth = 2.8", Height = 9"
Weight:	PIM: 5 lbs., Shipping weight: 5 lbs.

Table 6: ENVIRONMENTAL SPECIFICATIONS

Environmental Specifications	
Temperature:	- 40°C to +74°C.

Table 7: BATTERY SPECIFICATIONS

Battery Specifications	
Temperature:	- 40°C to +74°C.
Ampere-Hour ratings:	see Table 8 Table 8 Table 8
Hydrogen gas emissions:	meets Mil-Spec #MIL-B-8565J

Formatted: Font: 11 pt, Not Bold

Formatted: Font: 11 pt, Not Bold

Table 8: CLARY OutPost™ BATTERIES*

Clary Part. No.*	Volts/ A-hrs.	Estimated Runtime (Per set @ 77°F / 25°C) (New Batteries, fully charged)				Unit Weight	Overall Dimensions Per Battery Inches (cm.)		
		300 Watts	700 Watts	1050 Watts	1400 Watts		Length L	Width W	Height H
OP96C (Set of 8 Batteries)	12 VDC/ 41 AH	8.5 Hrs.**	3.5 Hrs.**	1.5 Hrs.**	1.0 Hrs.**	29 (13.2)	7.68 (19.6)	5.15 (13.1)	7.9 (20.1)

*OP96X battery sets include eight (8) batteries per set. Wired in series, each set provides 96 VDC.

**Actual times may vary. Runtimes are dependent on many factors.

Lower/Higher AH capacity batteries, allowing less or more runtime, are available on special order. Call factory for more information.

Communications, Controls & Diagnostics

Alarm Function Monitoring: The traffic UPS comes standard with a DB-9F connector with open collectors (40 V @ 20 mA) indicating On-Battery, Low-Battery, Timeout on-battery and Alarm.

A separate RS232 Interface is provided via a DB-9F connector allowing full, interactive, remote computer monitoring and control of the UPS functions via standard UPS protocols.

Optional TCPIP/ETHERNET available.

Front Panel controls: Power ON, Cold (DC) Start, Alarm Silence, Battery Test, Bypass Circuit Breaker, and DC/Battery Circuit Breaker.

Section 3

INSTALLATION AND OPERATIONS

3.1 INSTALLATION

The UPS system is typically rack or shelf-mounted in standard traffic cabinets. When determining how to position the UPS system inside your cabinet, the following requirements **MUST** be met.

- The installation site **MUST** maintain an ambient air temperature of less than 165°F (74°C).
- The air inlets, vents and fan **MUST NOT** be obstructed or blocked in any way. There **MUST BE** clearance around each air-inlet and vent.
- The air should remain free from excessive dust and chemical fumes.
- Total power requirements to be drawn from the UPS must not exceed the rated power of the UPS.

Please note these items when designing the UPS system's mounting hardware:

- The front panel is designed to fit in a standard 19" rack. This panel fills a 5.25-inch slot.

3.2 PREPARATION

Installation of the SP Series Traffic UPS must be preceded by careful preparation. The following steps are typical:

- Ensure that the Installation Requirements will be met. (See previous section).
- Read this manual thoroughly.
- Assemble wiring diagrams.

- Unpack and ensure that all UPS System components are on-hand and operative:
 - UPS System Module
 - Power Interface Module (PIM) w/mounting bracket
 - Battery Module (8 batteries w/cabling)
- Collect appropriate mounting hardware for the particular installation.
 - For 170/332 cabinets only, one or two battery trays (per shipping documents, depends on version purchased)
- Assemble your tools and inventory your equipment. Table 9 is a checklist of items that have proved useful during previous installations.
- Contact the responsible agencies to schedule a brief power down (10 to 15 minutes) at the intersection(s) affected.
- Allot 2 hours of time for the installation.

Formatted: Font: Not Bold

Formatted: Font: Not Bold

Table 9: RECOMMENDED INSTALLATION EQUIPMENT

Armored sheathing (cable protector)	Connectors (butt type and insulated)
Cordless drill w/ bits and a spare battery pack	Crimpers (for insulated and non-insulated connectors)
Dikes	DVM w/ probes
Electrical Tape	Flat Head screwdriver
Hardware in spill-proof carrying case	Hold-downs (adhesive back)
Nut Driver Set	#2 Phillips head screwdriver
Phillips head drill bit	Propane torch (miniature) or cigarette lighter
Shrink tubing	Socket Set
Socket Wrench	Current Clamp Meter or Probe
Wire cutters	Wire strippers

3.3 PROCEDURE

The recommended installation procedure is presented in Table 10 . The Table refers to, which presents a schematic wiring diagram.

Read through the entire procedure before beginning. If any steps are unclear, do not begin the installation process – please contact Clary Corporation for assistance.

Finish each step completely before continuing to the next.

Table 10: INSTALLATION PROCEDURE FOR TRAFFIC UPS

1. Mount Power Interface Module (PIM) in *Vertical Position*. The PIM mounting bracket can be removed and repositioned in a number of different directions to accommodate most applications. The PIM may be mounted near the bottom of the cabinet perpendicular to the sidewall.

IMPORTANT! PIM 60 MUST BE MOUNTED IN A VERTICAL POSITION.

2. Disconnect utility input from input terminal block (cabinet side) and connect to Out H terminal of PIM.
3. Connect Common N terminal of PIM to neutral bus using AWG #8 wire.
4. Connect Common G terminal of PIM to ground bus using AWG #8 wire.
5. Connect Flash connections in the PIM.
 - a. If immediate Flash on battery is desired, connect to “On Batt” terminals. (“FLASH” for PIM 60)
 - b. If delayed Flash on battery is desired, connect to either “Timer” or “Low-Batt”, depending on installation needs. (Only on PIM 30)
 - c. Use either NO or NC contacts as required.
 - d. “Timer” and “Low-Batt” connections can be paralleled if desired to produce Flash if either condition is present. (Only on PIM 30)
6. Connect utility input cabinet side to input H of PIM.
7. Mount UPS in cabinet.
8. Mount batteries and connect interconnect cables.
9. Connect PIM to UPS:
 - a. Power cable (circular connector and cable)
 - b. Signal port (db9 style connector and cable) (Only on PIM 30) **Note: Green LED on bottom of PIM30 must be illuminated for delays to work properly.**
10. Connect batteries to UPS. Make sure eight batteries are wired in series (+ to -) with 96VDC full potential across complete string.
11. Test installation for proper operation.
12. Document installation.

3.4 OPERATING CONFIGURATION AND SETUP:

Figure 1 shows how the PIM is connected to the traffic cabinet. This schematic diagram illustrates the interconnections.

Figure 3: PIM TO CABINET INTERCONNECTIONS

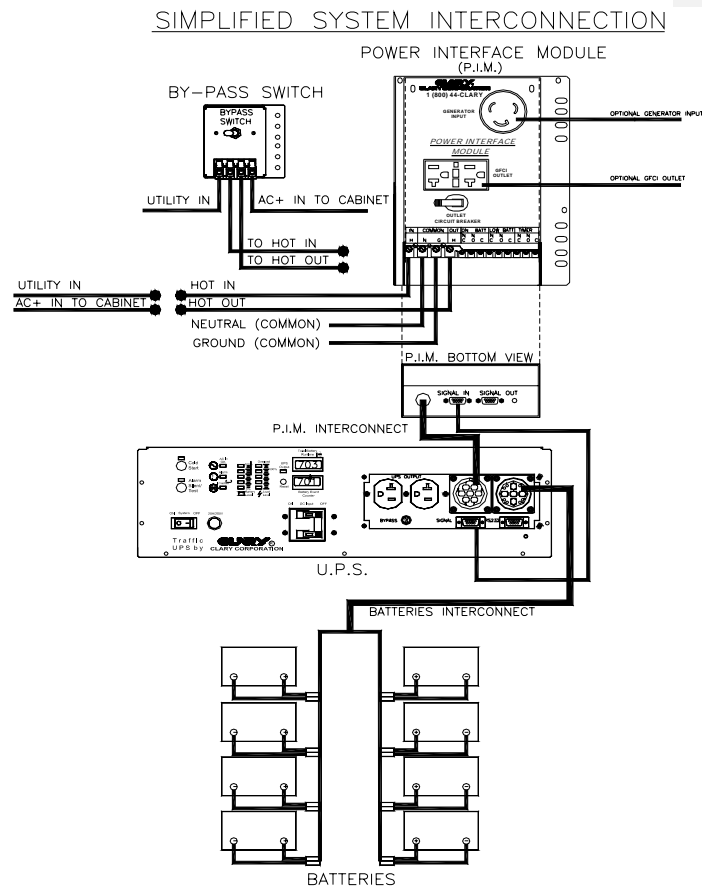

3.5 PIM: SUMMARY OF CONNECTORS

Figure 4: PIM30 & PIM60-FRONT VIEW

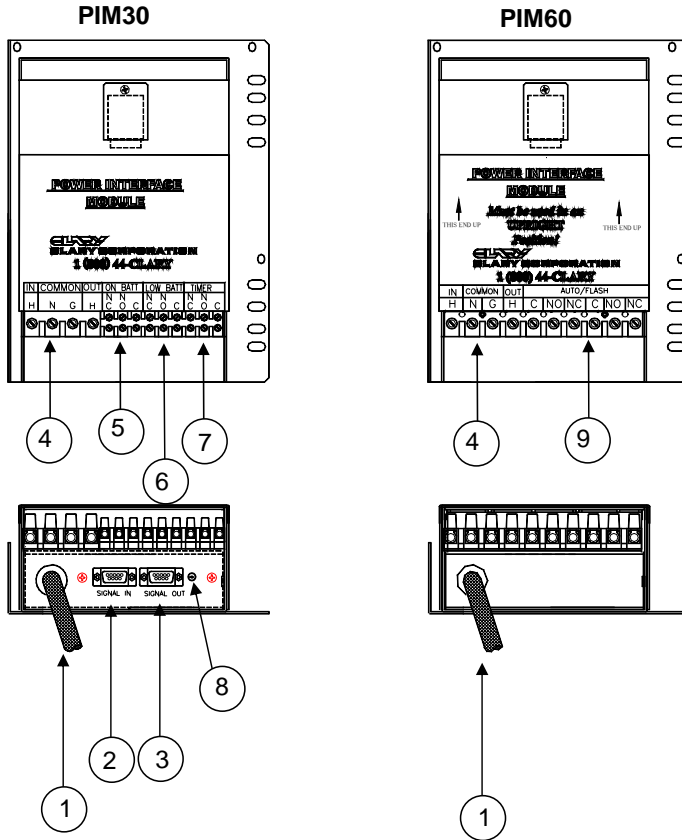

PIM30 & PIM60			
1	AC IN/OUT CABLE TO UPS	6	NO AND NC RELAY CONTACTS FOR "LOW BATTERY"
2	SIGNAL CONNECTION TO UPS	7	NO AND NC RELAY CONTACTS FOR "TIMER"
3	OPEN COLLECTOR	8	LED INDICATING SIGNAL CONNECTION TO UPS
4	MAIN POWER TERMINAL BLOCK (HIGH VOLTAGE)	9	NO AND NC RELAY CONTACT FOR "FOR FLASH AND STOP TIME"
5	NO AND NC RELAY CONTACTS FOR "ON BATTERY"		

Figure 5: Power Interface Module (PIM30)– Simplified Schematic Diagram

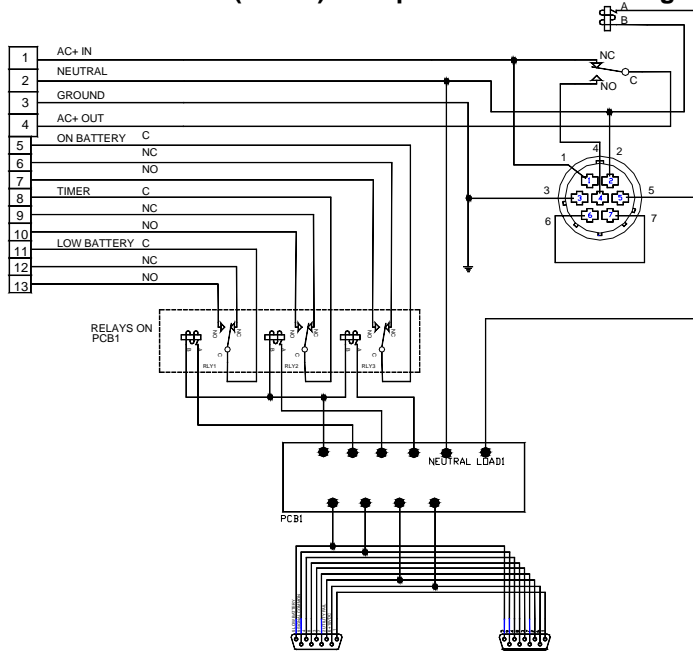
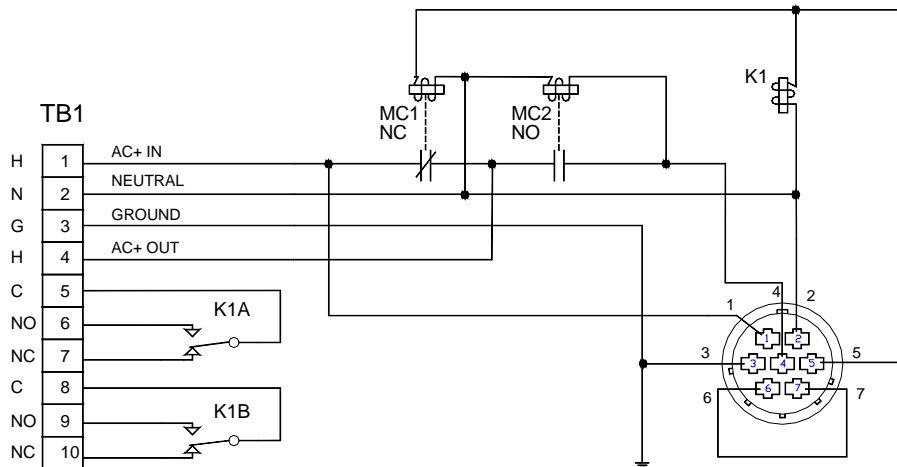

Figure 6: Power Interface Module (PIM60) – Simplified Schematic Diagram



3.6 OPERATION

Once the system has been properly installed, it is ready to operate. The following procedures will explain how to start-up the system while wired into rated electrical power and also how to start-up with no AC power available.

Normal Operation on AC Start-Up:

- Verify that the unit is wired into properly rated electrical power through the Power Interface Module (PIM).
- The AC IN and DC IN cables must be fully connected to the unit. There is an interlock system that will not allow the SP unit to operate if either of these connectors are open.
- Position the DC breaker to the **ON** position. Must be turned on before turning on System Switch. If not done in this order, you may see the Battery LEDs flashing.
- Position the System Power Switch to the **ON** position.

The system will proceed through about a three-second diagnostic where all the lights will sequence **ON** then **OFF**. The AC IN light will flash several times and the audible alarm will give a short burst. The AC IN light will then stay **ON** once it acknowledges acceptable input voltage and frequency. The battery level meter will light to indicate battery charge. The INVERTER light will come **ON** and power will be available at the output receptacles.

Continuous power is available at the output receptacles from the inverter. If the inverter is powered down or should malfunction, a bypass circuit will maintain power at this receptacle. This bypass line is protected through the Bypass breaker.

Battery Operation after AC Start-Up:

- Remove AC power from the system.

The AC ON light will flash. In *stand-by mode*, inverter power will be supplied to the PIM in two timing steps to control the traffic equipment wired to the SP system, now powering the cabinet in *flash mode*. In *continuous mode*, the cabinet operation will continue without interruption. A small hourglass will be in motion within the HOUR METER.

If operation were to continue in this mode, the BATTERY LEVEL meter would start to turn **OFF**, one light at a time. If the unit is allowed to operate further, it will time out and shut off completely. If power were to return, the unit will automatically restart and return to the condition it was in at the moment it went into *Battery Mode*.

Once power is returned, if in *standby mode*, inverter power to the traffic equipment will be discontinued through the PIM in a sequenced timing operation. In *continuous mode*, the cabinet operation will continue to operate without interruption. The EVENT COUNTER METER will increment. The EVENT COUNTER METER can be reset by momentarily pushing the RESET button located between the meters.

Total battery operation is recorded on the HOUR METER.

DC Start Operation (Cold Start)

If no utility power is available at the time backup power is required, the unit may be started to accomplish abbreviated tasks. The limitations of the battery prevent extended operations at full load.

- Position the DC Input Breaker to the **ON** position.

- Position the System Power Switch to the **ON** position.
- Push and hold in the COLD START switch until the audible alarm beeps.

The unit will start up similarly to normal AC start-up except the AC IN LED will continue to flash. It will now operate as described above in battery operation.

Loading the System

The system can be loaded up to full rated load. As load is applied, the LOAD METER will start to turn **ON**. Once full load is achieved, the full LOAD METER should be lit. As additional load is applied, the top red OVERLOAD LED will come **ON**. If too much overload is applied, the audible alarm will sound. If this increased load is not removed within five seconds, the unit will discontinue output operation and latch into an alarm condition. The audible alarm will continue to sound and the ALARM LED will light. Reducing the load and cycling the System Power Switch **OFF** then **ON** can reset the system.

Battery Self Test

Periodically the unit will perform a battery self test. The test is set to run every 160 hours. If unit fails battery self test, the battery status indicators will be flashing. If this happens, see Page 42 for troubleshooting help. Note: This test does not replace the need for regular battery maintenance checks.

3.7 Optional Communication Procedure

The UPS system includes additional interfaces for communications to host computers or other similar devices. Their use is optional, but allows for remote monitoring and control of the power system. Effective utilization of these capabilities will enhance the reliability of the traffic power system.

There are two DB-9, subminiature, female connectors. These are provided for communications links to a computer or sophisticated monitoring device. These two connectors are labeled and used as:

- o SIGNAL provides open collector type contact closures that signal *Utility Interrupt*, *Low Battery* and *Timer* conditions to the PIM. These in turn, activate the respective relays named 'On-Batt', 'Low-Batt', and 'Timer'. The SIGNAL port cables to the PIM. The PIM provides a pass-through port to make these signals available to the user.
- o RS232 is a true communications signal port. This port connects to standard PC-type serial ports.

SIGNAL PORT

- 2- AC INPUT FAIL/FLASH TIMER
- 3- UPS ON
- 4- COMMON SIGNAL RETURN
- 5- LOW BATTERY
- 6- +9VDC
- 8- +9VDC

RS232 PORT

- 1- LOW BATTERY
- 2- TX
- 3- RX
- 4- RS232 SHUTDOWN
- 5- GROUND
- 6- +9V
- 8- AC FAIL

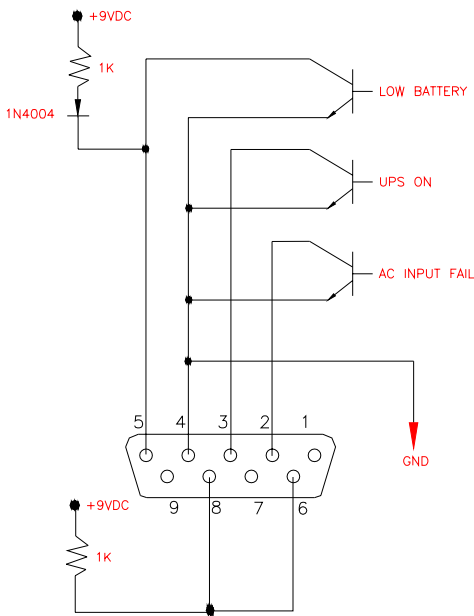

**SIGNAL: DB-9
CONNECTOR**

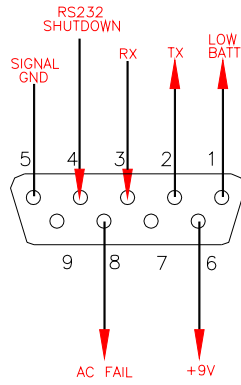

**RS232: DB-9
CONNECTOR**

Figure 3: SIGNAL/RS232 PIN ASSIGNMENTS

Section 4

ADJUSTMENTS

4.1 Adjustment Overview for DOS Programs

CAUTION: The UPS has no required nor recommended field adjustments.

There are programmable features and calibrations used by the UPS. These are always preset in the factory and fall into these categories:

- Identification: An assigned Factory ID Number and a User-programmable ID String.
- Statistical Information: Count and Timings of various modes. Reset to all zeros at the factory.
- Option and Configuration Settings: Used to specify certain operations such as *Continuous* or *Standby* Operation. Delay Flash indications (voltage trip points and time-out periods) can also be specified.
- Calibration: Used to compensate for small offsets in reading internal voltages.

A factory supplied PC computer program SP1000.EXE is used to change these values. Information is provided on how SP1000.EXE can be used to monitor and configure the UPS.

CAUTION: NEVER CHANGE ANY CALIBRATION PARAMETERS. Calibration Parameters are calculated by special purpose factory instruments and the settings are particular to each UPS. Changing these parameters can cause the UPS to malfunction. The factory keeps records of the settings of each machine.

USING SP1000.EXE

SP1000.exe is distributed on a diskette. It requires a Laptop with serial port COM1 available. The program runs under DOS and/or Windows. Copy all files to any directory on the hard-drive.

Connect the UPS's RS232 port to the Laptop's COM1 port. The UPS is ready for communications whenever it is powered on.

Initiate the program by opening a MS-DOS command window or restarting in MS-DOS mode. Then issue the command:

C:> SP1000

A window is presented giving various options. Submenus are available.

```
Clary Digital SP1000 Command Program          Access:  DEBUG
Version 12 of March 19, 2001

Command Choices:

?>  Menu
Q>  Quit

G>  Control UPS Operation...
R>  Reset UPS Oper/Stats...
S>  Set Configuration...

A>  Alarm Status
B>  Battery Status
C>  Configuration Status
I>  Input Status
O>  Output Status
U>  User Status
Z>  UPS Statistics

X>  Diagnostics & Test ...

Command [?=Menu, Q=Quit] >
```

CONFIGURING OPERATING CHARACTERISTICS

The UPS can be configured to operate either in Continuous or Standby Mode. The parameters associated with Flash operation can also be set.

Start SP1000.exe. Enter 'V' to select Options Programming. The following menu is presented:

```
Option Settings:

1> OPT_STARTUP           = 0F (hex)
2> OPT_RPANEL           = 00 (hex)
3> OPT_FPANEL           = FF (hex)
4> OPT_TRAFFIC          = 20 (hex)
5> OPT_MISC              = 06 (hex)
6> OPT_ALARM            = 01 (hex)
7> BACKUP DELAY (x10 msec) = 4
8> OPT_DEBUG            = 00 (hex)

A> FLASH TRIGGER (Min.s) = 120
B> FLASH TRIGGER (Volts) = 69
C> BACKUP STANDBY TIMEOUT = 0
D> BAT. TEST PERIOD (HRS) = 0
E> INTERFACE DELAY (x10 msec) = 0

Set Option Number: [q=quit,r=re-read] >
```

Enter the appropriate menu selection (1-8,A-E) to change a parameter.

Selections 1-8 represent numbers 0-255 and are entered in HEX format but without the 'H' indicator. For example, the number 47 is represented as 2F in HEX, '2F' would be entered. These values are stored in one byte (8 bits) in the UPS and interpreted bit-by-bit by the UPS firmware. Each of the 8 bits potentially can be used to carry information, however, only a few bits in each byte are used.

The options of relevance to the SP-1000 UPS system are described below. For these options: the bit-mapping, default, and notes are given.

OPT_TRAFFIC: (Enter Hex value)

OPT_TRAFFIC	=1	=0
Bit 7 (MSB)	Long return always	Short return
6	Long return if Flash volt or minute triggers occurred.	Short return
5	SIGNAL port pin 2 carries Flash Timeout Trigger.	SIGNAL port pin 2 carries Utility Fail indication.
4	Brownout Protection Disabled	Brownout Protection Enabled
3	Reserved	Fixed 0
2	Reserved	Fixed 0
1	Bypass Disabled	Bypass Enabled
0	Bypass Overloads	Don't Bypass Overloads

Default: 30H

Notes:

- Long returns insert 2.5 second power breaks upon return from *Standby* operation. Short returns add no breaks.

OPT_MISC: (Enter Hex value)

OPT_MISC	=1	=0
Bit 7 (MSB)	Reserved	Fixed 0
6	Sets <i>Continuous</i> Operating Mode	Sets <i>Standby</i> Operating Mode
5	Reserved	Fixed 0
4	Reserved	Fixed 0
3	Reserved	Fixed 0
2	Battery Test enabled	Battery Test disabled
1	UPS output synched to utility.	Un-synched output
0	Fixed 1	Reserved.

Default: 06H

Notes:

- *Standby* operating mode is default.

BACKUP DELAY (x10 msec)

This value sets the time period of the utility AC noise rejection window. Utility disturbances of duration less than this setting are ignored. Units are in 10msec. For example, 40 millisecond delay is specified by 4.

Default: 4
Range: 1 – 100
Notes: Feature cannot be disabled.

FLASH TRIGGER (Volts)

Enter this value in decimal units of volts. This is the voltage specifies the trip point that activates the Flash operation via the "LOW-BATT" relay contacts in the PIM.

Default: 69
Range: 0 – 90V
Notes: 0 Disables feature

FLASH TRIGGER (Minutes)

Enter this value in decimal units of minutes. This is the voltage specifies the trip point that activates the Flash operation via the "TIMER" relay contacts in the PIM.

Default: 120
Range: 0 – 255 minutes
Notes: 0 Disables feature

4.2 Adjustment Overview for Windows Program

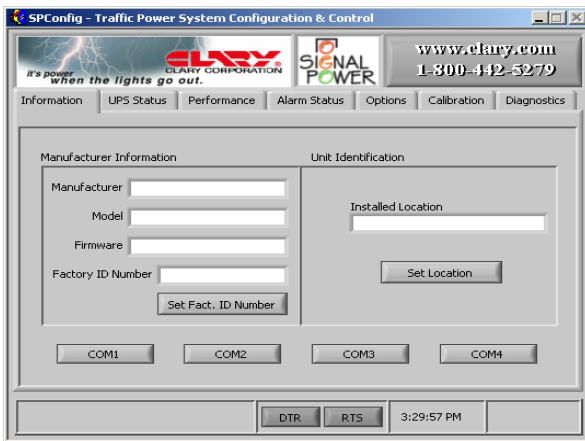

Open the Traffic UPS Program for Windows. Connect a straight through 9-pin RS232 cable from the computer serial port to the UPS RS232 port. Make sure UPS is turned on. Click OK. Select comport being used. Typically "Com1".

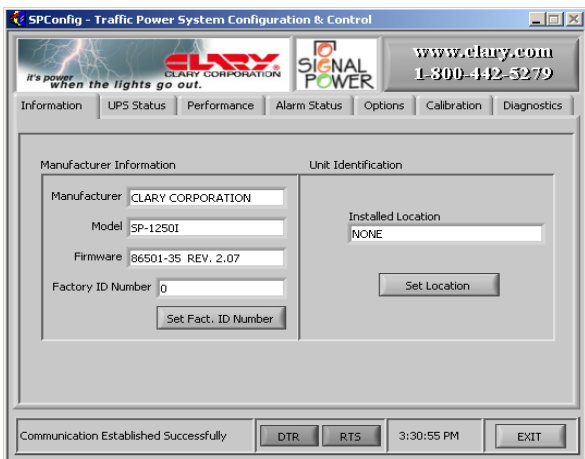

Once connected, you should see this screen. The Information screen gives you the model and firmware of the UPS.

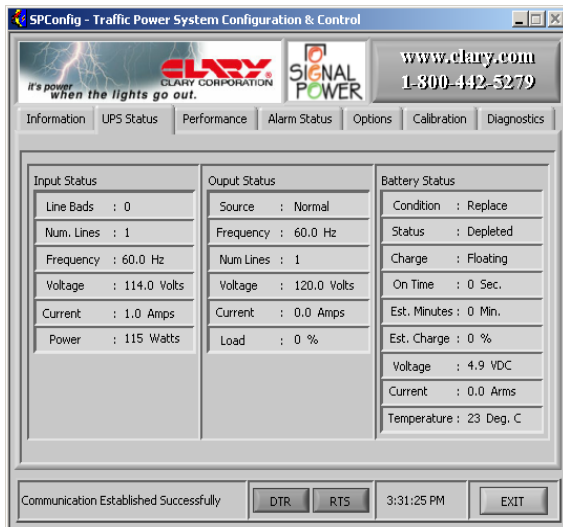

Click on the “UPS Status” tab. This screen shows the current UPS Input status, Output status and Battery Status.

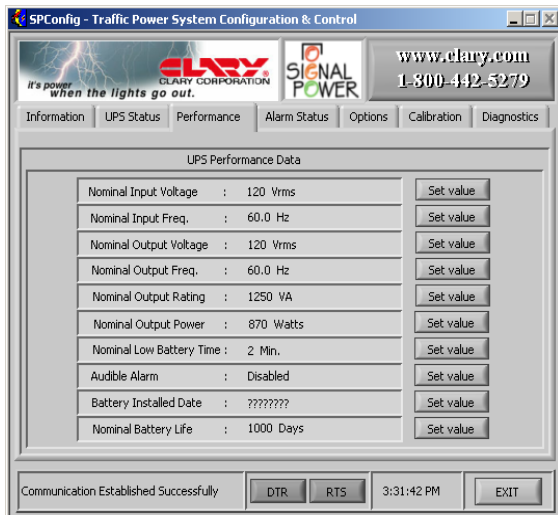

Click on the “Performance” tab. This screen shows the UPS Performance Data. The only two changeable features on this screen is the “Battery Install Date” and the “Audible Alarm”.



Click on the "Alarm Status" tab. This screen shows the type of alarm the unit is in.

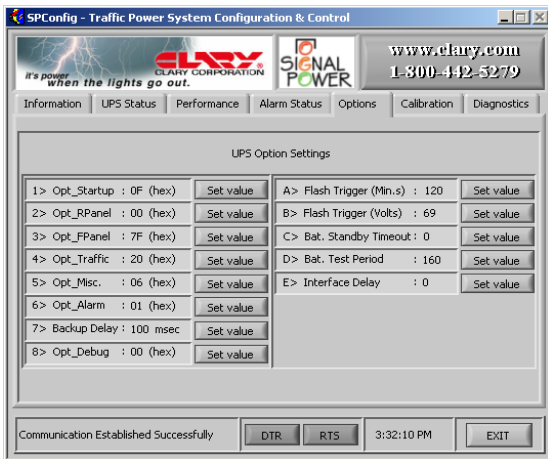

Click on the "Options" tab. From this screen you can change many of the options.

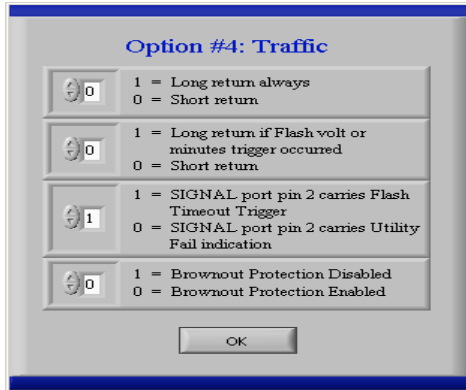

From the "Options" menu, click on the "Set value" tab for "4> Opt_Traffic."

- 1) This option used in the "Standby Mode".
 - a. The "Long return always" is used to force a break in power for 2.5 seconds after the utility power returns. This is used in intersections when a hard-restart needs to be applied to various devices.
 - b. The "Short return"(which is the default) is used when no break in the power is needed.
- 2) This option is used in the "Continuous Operating Mode".
 - a. The "Long return if flash volt or minutes trigger occurred" is used to force a break in power for 2.5 seconds after the utility power returns if "Flash trigger" in minutes or volts occurs.
 - b. The "Short return" (which is the default) is used when no break in the power is needed.
- 3) a. *The "Signal port pin 2 carries Flash Timeout Trigger" enables the "Timed Delayed Flash" feature. This feature enables you to activate the Timer NOWC contacts.*
 - b. The "Signal port pin 2 carries Utility Fail indication" disables the "Timer Delayed Flash" feature. The Timer NOWC contacts become active when utility Power is lost.

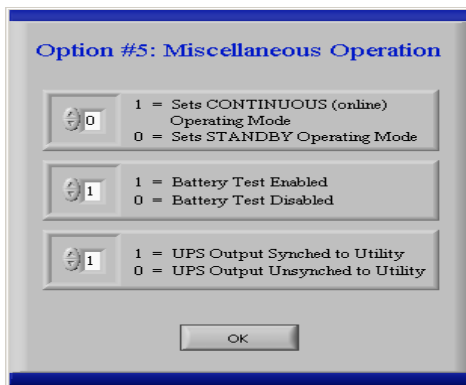

From the "Options" menu, click on the "Set value" tab for 5> Opt_Misc.

- 1) a. The "Sets CONTINUOUS (online) Operating Mode" is to set the UPS into Continuous operation.
 - b. The "Sets STANDBY Operating Mode" is to set the UPS into Standby operation.

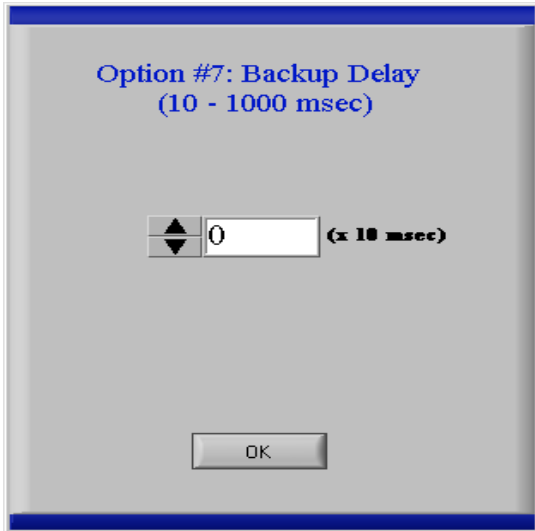

From the "Options" menu, click on the "Set Value" tab for 7> Backup Delay.
The Backup Delay allows you to set the time period of the utility AC noise rejection window.
Utility disturbances of duration less than this setting are ignored. Units are in 10msec.

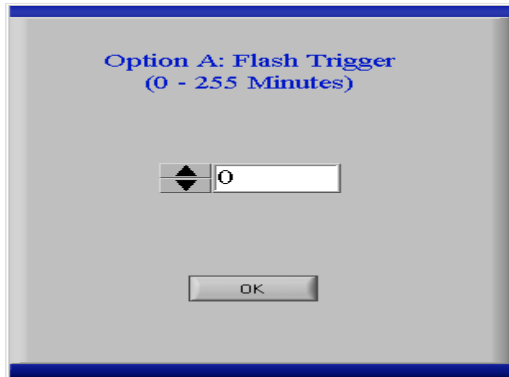

From the "Options" menu, click on the "Set Value" tab for A> Flash Trigger (Min.s). This is the time that specifies the trip point that activates the Flash operation via the "TIMER" relay contacts after Utility power is lost.

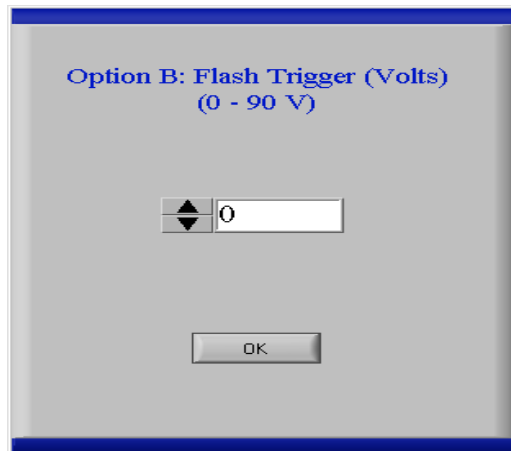

From the "Options" menu, click on the "Set Value" tab for B> Flash Trigger (Volts). This is the Battery Voltage that specifies the trip point that activates the Flash operation via the "TIMER" relay contacts.

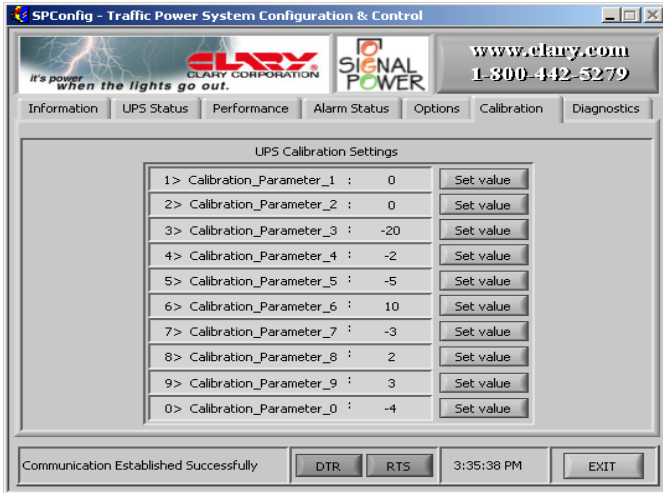

This is the Calibration Settings for the UPS. **DO NOT CHANGE ANY OF THESE UNLESS INSTRUCTED TO DO SO BY THE FACTORY.**

Section 5

CARE AND MAINTENANCE

5.1 SAFETY

There are hazardous high voltages and materials present in the UPS system which present safety risks. You **MUST** follow basic safety procedures when maintaining the UPS. In addition please note the following:

ELECTRICAL SAFETY



- Hazardous high voltages are present in this product, which can cause electrical shock.
- Do not work alone under hazardous conditions.
- Always wear eye-protection when servicing energized power electronics.
- Connect equipment only to three wire AC outlets (two poles plus ground). The receptacle must be connected to an appropriate protected branch circuit (fuse or circuit breaker).
- Connecting this equipment in a manner other than specified may result in a shock hazard and may violate local electrical codes.

DE-ENERGIZING SAFETY

- To de-energize the UPS, BOTH the AC Power connector and the DC Power connectors must be disconnected.
- There is internal energy storage in the UPS Power Module. This energy is stored in Capacitors, which require at least 2 minutes of discharge time after power is disconnected.

5.2 PREVENTIVE MAINTENANCE

CLEANING

This device is designed to be maintenance-free. It can be cleaned with a damp cloth or nonabrasive cleanser.

WARNING: Do not use ACETONE-BASE cleaning solutions. Keep cleaning solutions out of the electrical receptacles on this device.

Be sure filters, vents and fans are kept free from accumulation of dust, dirt or lint. Below (see [Table 11](#) ~~Table 11~~ ~~Table 14~~) is a simple maintenance schedule that will assist you in keeping the system at its peak level of performance and also minimizing potential premature failures.

Formatted: Font: 11 pt, Not Bold

Formatted: Font: 11 pt, Not Bold

BATTERIES

Your system contains sealed maintenance-free batteries. When situated in the proper environment, with the proper charging and limited cycling, these batteries can last many years.

Battery replacement should be performed or supervised by personnel familiar with the dangers of batteries and the required precautions. DO NOT permit untrained or unauthorized personnel to replace or service batteries.

WARNING: Never attempt to service batteries. Servicing of batteries should be performed or supervised by personnel knowledgeable of batteries and the required precautions. Keep unauthorized personnel away from batteries. When replacing batteries, use the same number and type batteries.

CAUTION: Do not dispose of battery or batteries in a fire. The battery may explode.

CAUTION: Do not open or mutilate the battery or batteries. Released electrolyte is harmful to the skin and eyes. It may be toxic.

CAUTION: A battery can present a risk of electrical shock and high short circuit current. The following precautions should be observed when working on batteries:

1. Remove watches, rings, or other metal objects.
2. Use tools with insulated handles.
3. Wear rubber gloves and boots.
4. Do not lay tools or metal parts on top of batteries.
5. Disconnect the charging source prior to connecting or disconnecting battery terminals.
6. Determine if the battery is inadvertently grounded. If inadvertently grounded, remove source of ground. Contact with any part of a grounded battery can result in electrical shock. The likelihood of such shock will be reduced if such grounds are removed during installation and maintenance.
7. The rechargeable battery is recyclable. At the end of its useful life, under various state and local laws, it may be illegal to dispose of this battery into the municipal waste stream. Check with the factory for details in your area for recycling options or proper disposal.

BATTERY RECYCLING



- The batteries used in this equipment are recyclable. Proper disposal is required and mandated by law. The batteries contain lead and pose a hazard to the environment and human health if not disposed of properly.
- Refer to local codes for proper disposal requirements or return the batteries to the factory.
- ALWAYS contact the factory for information concerning shipment, disposal, or replacement of batteries.

Table 11: PREVENTIVE MAINTENANCE SCHEDULE

Item	Schedule	Actions
Cleaning	6 Mos.	Blow out unit with air.
Battery	6 Mos.	Clean terminals and check for corrosion.
Fans	6 Mos.	Check for proper operation.

5.3 TROUBLE ANALYSIS

Unit does not power up:

- Make sure AC & DC input connectors are connected and seated properly.
- Check front panel fuse(F1)
- Check PIM for proper installation and wiring.

Battery LED's on front panel is flashing:

- Make sure when you power up the unit, turn DC breaker on first, then turn on the system switch.
- Possible Bad Battery
 - Check each battery with a battery tester
- Possible faulty connection to Batteries
 - Check all connectors for proper pin alignment and any corrosive build up.

No Backup when utility power is lost:

- Make sure DC breaker is in the "ON" position.
- If Bypass switch is installed, make sure it is in the "UPS" position.
- Check PIM for proper installation and wiring.
- Possible Bad PIM.
- Check Batteries.

Front Panel Fuse(F1) keeps going bad:

- Possible bad inverter.

On turn on, Unit goes through startup sequence then goes into alarm and inverter does not turn on:

- Possible bad inverter.

- Load on unit may be over Max. rating.

Unit in Alarm, but is still operating OK:

- Possible over temp.
- Check fans in the unit to make sure they are running.

In On-line operation, intersection goes into flash when utility power is loss:

- Check PIM for proper installation and wiring.
- Options in the program may not be set properly.

5.4 SERVICE AND REPAIR

Your **SP Series** UPS is backed by one of the finest customer service teams available. Write or call them at any time to obtain more information about your unit.

Clary Corporation
150 E. Huntington Drive
Monrovia, CA 91016
1-800-551-6111

If a problem should occur, it is important that you obtain a Return Material Authorization (RMA) number from the Service Department to process any unit returned to the factory. In consulting the factory, always have the unit model number and serial number at hand. This information is located on the identification label and is essential in retrieving your unit's performance and history record.

The RMA number issued to you should appear on the outside of the carton, if the unit is returned, or on any correspondence regarding your unit. When shipping a unit back to the factory, try to use the original packing container and shipping materials. The Service Department cannot take responsibility for any unit damaged in return shipment. All units must be returned prepaid to:

Clary Corporation
Service Department
150 E. Huntington Drive
Monrovia, CA 91016

WARRANTY

1. TIME AND SCOPE OF WARRANTY:

- 1.1. Clary Corporation hereby warrants parts shipped under this Agreement to be free from defective workmanship for a period of 2 years following date of shipment. Accidental damage, misuse or normal wear and tear shall not be construed as a defect.
- 1.2. The date of shipment as used herein will be the date on the Bill of Lading. If no Bill of Lading is issued the date of shipment shall be shown on seller's shipping document.
- 1.3. No provision of this warranty shall cover equipment that has been altered or modified from the original specifications to which it was manufactured unless authorized in writing.
- 1.4. No provision of this warranty shall cover batteries. However, battery manufacturer's warranties will be passed through to the customer whenever applicable.

2. LIMITS OF "IN WARRANTY" SERVICE LIABILITY:

- 2.1. Clary is obligated during the in-warranty period to provide service and/or adjustments to equipment returned to the factory at the expense of buyer (the term "factory" as used here-in shall also include any field service centers which may be established by Clary) and to repair or replace any part(s) thereof which in the opinion of authorized Clary personnel are found to have been defective.
 - 2.2. Equipment requiring in-warranty services must be returned to the factory with all transportation charges prepaid, clearly tagged, and stating the nature of the trouble experienced, and the disposition of the equipment after repair. The equipment will be returned collect by Clary to the location specified via the best, least expensive carrier available or via customer's shipping instructions.
 - 2.3. The nature of certain equipment installations may be such that it would be impractical or technically infeasible to remove the Clary portion of the equipment from the customer's premises to the Clary factory. In such cases, and at the request of the buyer, Clary will perform such service as can be satisfactorily rendered at buyer's location. The buyer will be charged only for travel expenses incidental to the service call, provided that the warranty is applicable.
 - 2.4. During the in-warranty period, no service charges shall be payable by the buyer for service performed other than for service necessitated by accident, misuse, theft, abnormal line or source voltage fluctuations, abnormal conditions of operation, damage by the elements or damage resulting from adjustments, repairs, modifications made by other than Clary Authorized personnel, or the buyer's failure to reasonably maintain the equipment.
 - 2.5. **THE FOREGOING WARRANTY IS EXCLUSIVE AND IS GIVEN AND ACCEPTED IN LIEU OF ANY AND ALL OTHER WARRANTIES, EXPRESSED OR IMPLIED, INCLUDING WITHOUT LIMITATION THE IMPLIED WARRANTIES OF MERCHANTABILITY AND FITNESS FOR A PARTICULAR PURPOSE. THE REMEDIES OF BUYER SHALL BE LIMITED TO THOSE PROVIDED HEREIN. IN NO EVENT WILL SELLER BE LIABLE FOR COLLATERAL OR CONSEQUENTIAL DAMAGES.** No person is authorized to assume in behalf of Clary any obligation or liability in connection with the sale, warranty or service policy of any products manufactured and/or marketed by Clary Corporation beyond the warranty description on the face hereof.
3. **Clary Corporation reserves the right to make changes, additions, and/or improvements in its products without incurring any obligation to install them on its products previously sold.**