

# User & Service Manual

## PD SERIES CONTINUOUS POWER SYSTEM

**MODELS COVERED:**  
**SP1250PD-R/N**  
**SP1250PD-R/N (PLUS)**  
**SP2000PD-R/N**

**CLARY CORPORATION**  
150 E. Huntington Drive  
Monrovia, California 91016  
Telephone ☎ 626-359-4486  
☎ 800-44 CLARY  
Fax. ☎ 626-305-0254  
World Wide Web 🌐 [HTTP: // WWW.CLARY.COM](http://WWW.CLARY.COM)  
E-Mail 📧 [SALES @ CLARY.COM](mailto:SALES@CLARY.COM)

Information contained herein is the property of Clary Corporation, is proprietary, confidential, and not to be disclosed, disseminated or used except for the purpose provided by  
CLARY CORPORATION

**TABLE OF CONTENTS**

<b>1</b>	<b>GENERAL DESCRIPTION .....</b>	<b>5</b>
1.1	Introduction .....	5
1.2	Operating Modes .....	6
1.3	Physical Description.....	8
1.4	Summary Of Connectors – Bypass Box .....	12
<b>2</b>	<b>GENERAL CHARACTERISTICS .....</b>	<b>14</b>
2.1	Characteristics .....	14
2.2	Specifications.....	17
<b>3</b>	<b>INSTALLATION AND OPERATIONS .....</b>	<b>20</b>
3.1	Installation.....	20
3.2	Preparation .....	20
3.3	Procedure .....	22
3.4	Operating Configuration and Setup: .....	23
3.5	Start-up .....	24
3.6	Optional Communication Procedure.....	25
<b>4</b>	<b>PROGRAMMABLE LCD DISPLAY.....</b>	<b>27</b>
4.1	Introduction .....	27
4.2	Normal Mode .....	28
4.3	Battery System Status .....	28
4.4	Power System Status .....	30
4.5	UPS System Status .....	31
4.6	UPS Information.....	32
4.7	Event Log.....	33
4.8	Options.....	33
4.9	Time and Date .....	36
4.10	Relays .....	37
<b>5</b>	<b>CARE AND MAINTENANCE.....</b>	<b>42</b>
5.1	Safety.....	42
5.2	Preventive Maintenance .....	43
5.3	Trouble Analysis .....	44
5.4	Service and Repair .....	45
<b>6</b>	<b>SCHEMATICS .....</b>	<b>46</b>
	<b>WARRANTY .....</b>	<b>47</b>

**LIST OF FIGURES**

Figure 1: FRONT PANEL VIEW (N)..... 9  
Figure 2: BYPASS BOX ..... 12  
Figure 3: BYPASS BOX with GFCI Option ..... 13  
Figure 3: UPS TO CABINET INTERCONNECTIONS..... 23  
Figure 4: SIGNAL/RS232 PIN ASSIGNMENTS..... 26

**LIST OF TABLES**

Table 1: FIGURE 1 DESCRIPTIONS ..... 10  
Table 2: BYPASS BOX DESCRIPTIONS ..... 12  
Table 3: BYPASS BOX DESCRIPTIONS ..... 13  
Table 4: ELECTRICAL SPECIFICATIONS..... 17  
Table 5: Physical Specifications, UPS Electronics Module ..... 18  
Table 6: PHYSICAL SPECIFICATIONS..... 18  
Table 7: ENVIRONMENTAL SPECIFICATIONS ..... 18  
Table 8: BATTERY SPECIFICATIONS ..... 18  
Table 9: CLARY OutPost™ BATTERIES\* ..... 19  
Table 10: RECOMMENDED INSTALLATION EQUIPMENT ..... 21  
Table 11: TYPICAL INSTALLATION PROCEDURE FOR TRAFFIC UPS ..... 22  
Table 12: LIST OF RULES ..... 40  
Table 13: ALARMS AND FAULTS ..... 41  
Table 14: DEFAULT SETTINGS ..... 41  
Table 15: PREVENTIVE MAINTENANCE SCHEDULE ..... 44

## “IMPORTANT SAFETY INSTRUCTIONS” “SAVE THESE INSTRUCTIONS”

This manual contains important safety instructions that should be followed during installation and maintenance of the UPS and batteries. The instructions should be followed during installation and maintenance of the UPS and batteries. Be aware of the following symbols and their meaning as they appear throughout the manual:

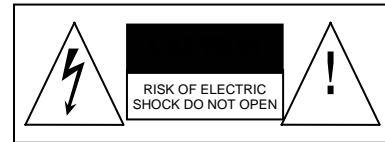
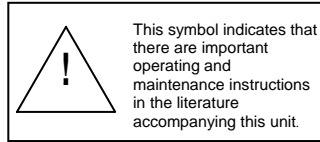
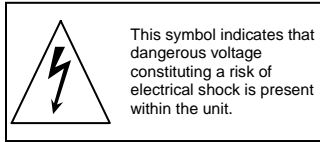

**Earth Ground Symbol:**



**On / Off Symbol:**

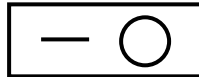

### Maximum Ambient Temperature 74° C.

This unit intended for installation in a controlled environment (temperature controlled, indoor area free of conductive contaminants).

**CAUTION** – Do not dispose of batteries in a fire. The batteries may explode.

**CAUTION** - Do not open or mutilate the batteries. Released electrolyte is harmful to the skin and eyes. It may be toxic.

**CAUTION** - A battery can present a risk of electrical shock and high short circuit current. The following precautions should be observed when working on batteries.

1. Remove watches, rings, or other metal objects.
2. Use tools with insulated handles.

### FCC-Rules

This equipment generates and uses radio frequency energy and if not installed and used properly in strict accordance with the manufacturer's instructions, may cause interference to radio and television reception. All units in this manual have been tested and found to comply with the limits for a Class A computing device in accordance with the specifications in Subpart J of Part 15 of FCC Rules, which are designed to provide reasonable protection against such interference in a commercial installation. However, there is no guarantee that interference will not occur in a particular installation. If this equipment does cause interference to radio and television reception, which can be determined by turning the equipment off and on, the user is encouraged to try to correct the interference by one or more of the following measures:

- ☐ Reorient the receiving antenna.
- ☐ Relocate the UPS with respect to the receiver.
- ☐ Move the UPS away from the receiver.
- ☐ Plug the UPS into a different outlet so that the UPS and receiver are on different branch circuits.

If necessary, the user should consult the dealer or an experienced radio/television technician for additional suggestions. The user may find the following booklet prepared by the Federal Communications Commission helpful:

"How To Identify and Resolve Radio-TV Interference Problems"

This booklet is available from the U.S. Government Printing Office, Washington, DC 20402, Stock No. 00400003454.

# 1 GENERAL DESCRIPTION

## 1.1 Introduction

You have selected the highest quality power protection system available for your traffic control devices. You now own a PD Series Traffic UPS (Uninterruptible Power System) with a programmable LCD display. The PD Series is an all *Digital Technology* UPS product designed and manufactured by Clary Corporation, the first name in UPS reliability. Clary UPS can be found on naval warships and submarines, hospital operating rooms, labs, water treatment plants and traffic intersections. The *PD Series* offers a rugged, compact package with superior features and performance you can depend on.

When power problems occur, there can be no compromising the operations and reliability of your traffic control devices - - and no compromising public safety. With fully conditioned, regenerative, sine wave power and military-quality battery backup, the PD Series Traffic UPS is your complete power solution.

This Owner's Operating Manual is provided with your new PD Series Traffic UPS. It will enhance your understanding of the product and its functions.

**WE STRONGLY URGE YOU TO READ THIS MANUAL COMPLETELY, PRIOR TO BEGINNING INSTALLATION OR ATTEMPTING OPERATION.**

Studying this manual will save you time and effort in your installation and application, and it will assure a trouble free installation and startup session, thus enhancing public safety and the image of your agency.

The illustrations provided will familiarize you with this product's operating modes and components. Always operate the unit within the guidelines and specifications provided to maximize safety and the lifetime of the unit. Your understanding of the product is a key element in assuring the proper use and effectiveness of the PD Series Traffic UPS.

## 1.2 Operating Modes

Clary's PD Series Uninterruptible Power Systems (UPS) are designed for powering low power (i.e., LED & NEON) traffic & pedestrian indications, plus critical traffic control devices (i.e., controllers, modems, CMU's, etc.). The power system consists of three elements, which work together to provide critical loads with continuous, conditioned, regulated, sinusoidal waveform power that is free from disturbances such as spikes, surges, brownouts or blackouts. These elements are the:

1. *UPS Module – (UPS)*
2. *Bypass Box*
3. *Battery Module*

Backup power is achieved with a set of rechargeable, SVRLA (sealed valve-regulated lead-acid), maintenance-free, AGM (absorbed glass mat), batteries. The complete UPS system is controlled by an onboard digital microprocessor at all times.

There are two basic modes of operation:

- *Offline (Standby Operating Mode)*
- *Online (Continuous Operating Mode)*

In both modes, the UPS continuously generates 120V AC power. The selected mode determines when and how the UPS generated power is applied to the loads in the traffic cabinet.

### **Standby Operating Mode (OFFLINE):**

During *Standby* operation, utility (AC) power enters the Bypass Box then into the UPS (if Bypass Box is switched to UPS) and passes through a normally closed relay, then directly out to the cabinet power bus, PDA, etc. This utility power is used to power the intersection until a power disturbance occurs at which time, the relay is switched, routing the UPS generated AC power to the cabinet power bus. Typically, the UPS will then be drawing its power from the battery pack. This operation continues until good utility power is restored, after which, the relays switch back to route the utility power to the loads.

With *Standby* operation, 0.5 seconds (user programmable from 30ms to 2.5sec) after an outage is detected, standby power is connected to the system and if desired, the Flash Command is initiated, forcing the cabinet into *Flash Mode* operation. Depending on the size of the battery system being used and the loading on the power system, backup power can continue for several hours. NOTE: If the flash mode operation is not desired, make sure intersection load is not over 875 watts.

When utility power returns, (or upon application of generator power) the PD Series UPS waits 30 seconds to be sure that the utility power has stabilized. After this built-in safety delay utility power is restored to the cabinet. The battery charger then recharges the batteries in typically 10 to 20 times (depending on the load) the duration of the outage or battery discharge time (whichever is shorter).

The UPS can be set to force a break in power of 2.5 seconds after utility power returns. This is optional (not the default) and is used in intersections when a hard-restart needs to be applied to various devices when returning from flash.

With *Standby* operation, the ONLY required change to cabinet wiring occurs by the introduction of the Bypass Box. Removal and Replacement (R&R) of the UPS module is quick and easy even with traffic control devices (TCD's) connected to the UPS. If no TCD's are plugged into the UPS module (i.e. being used for LED flash backup only), R&R of the UPS module (for upgrades or in the rare event of UPS failure) can be done without powering down the cabinet or otherwise affecting cabinet operation in any way.

### **Continuous Operating Mode (ONLINE):**

*Continuous* operation is used for low power applications such as full LED intersections, power to the intersection is continuously conditioned and backed up by the UPS. Within the limitation of the battery capacity, virtually all brownout and power outages are eliminated.

### **SP1250PD (PLUS) OPTIONAL**

The PLUS has an extended load option that will allow 1400watts peak load for ten seconds. This option allows for support of intersections that have not yet replaced the yellow incandescent traffic lamps.

### **Additional Notes on Operating Modes:**

- The PD Series Traffic UPS is designed for compatibility with, and complete transparency to, all traffic signal cabinet functions including police panel operation.

### **RELAY CONTACTS:**

The UPS includes eight (8) sets of normally-open (NO) and normally-closed (NC) relay style contacts. The contacts are intended to connect to the Flash controllers or other devices in the traffic cabinet. The contacts are actuated at various times as a means of signaling these devices of important aspects of current operation. These relays can be programmed from the Front Panel LCD Display. You can set any of the relays to a certain condition listed in Table 12. See section 4.10 for programming instructions.

### **1.3 Physical Description**

This section will point out and illustrate the various indicators, functions and controls of the PD Series UPS. The important attributes of the PD Series unit are numbered to assist you in locating them on your machine and also to fully explain its function and how it relates to system operation. Numbers on the drawing will correspond to the operating component's name at the bottom with a brief identification. In the next section, a complete explanation of all numbered items will be enhanced to ensure you have a full understanding of the operation of this system.

Visual indicators used on the front panel are long lasting, very efficient, light emitting diodes (LED). When operating the push-button switches, always hold the switch in for at least two seconds to insure function confirmation. This feature has been implemented into the system design to avoid inadvertent operation of any of the user-available functions.

Figure 1 is the front view of the model SP1250PD-N.



Table 1 describes items 1 – 22.

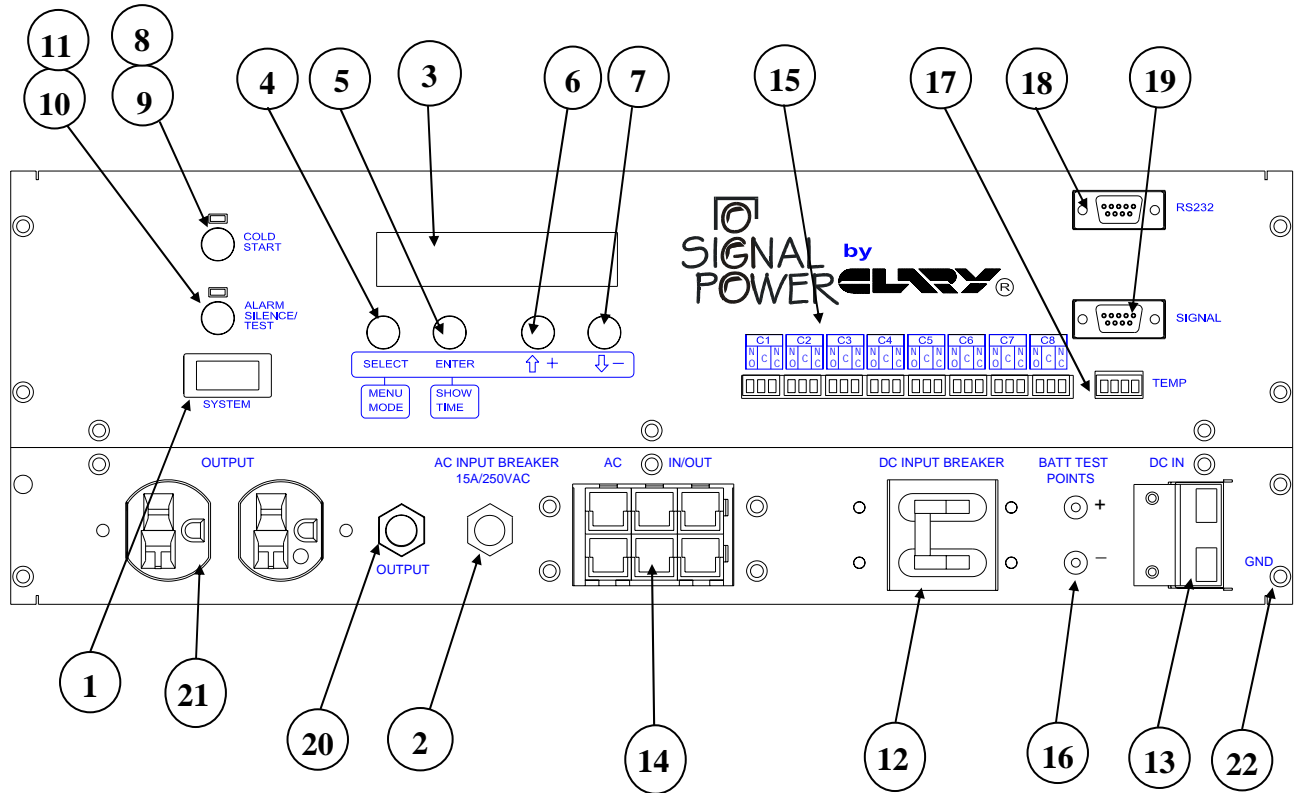

Figure 1: FRONT PANEL VIEW

Table 1: FIGURE 1 DESCRIPTIONS

<b>PANEL VIEW DESCRIPTIONS</b>			
1	SYSTEM POWER SWITCH	12	DC INPUT – Protection circuit breaker for battery
2	INPUT AC LINE BREAKER	13	DC IN – Input receptacle for all DC power (to Batteries)
3	LCD DISPLAY	14	AC IN / OUT – Input terminal block for all AC power to Bypass Box
4	SELECT/MENU MODE	15	RELAYS – NO/NC Contacts for Flash
5	ENTER/SHOW TIME	16	BATTERY TEST POINTS
6	UP ARROW +	17	AUX. TEMP. SENSOR – Input for Optional Aux. Temp. Sensor
7	DOWN ARROW -	18	RS232 – Computer communications signals
8	COLD START – DC start switch	19	SIGNAL – Open-collector signal contacts
9	COLD START INDICATOR	20	CIRCUIT BREAKER – Protection for output receptacles
10	ALARM SILENT/TEST – Dual function switch	21	OUTPUT RECEPTACLES – Continuous power receptacles
11	ALARM SILENT/TEST ACKNOWLEDGE INDICATOR	22	GND - GROUND POINT

## SUMMARY OF INDICATORS AND CONTROLS

**SYSTEM POWER SWITCH** - The main control switch that engages utility power to the entire unit. By activating this switch it initializes normal operation.

**DC INPUT** - A two pole, 20A (25A for SP1250PD (PLUS) & SP2000PD) circuit breaker used to connect the battery to the internal UPS electronics. It also protects against over-current situations in the battery circuit.

**INPUT AC LINE BREAKER** - The input line protection device to limit excessive current draw to the system on over-loads. Rated 15A/250V (20A for SP1250PD (Plus) & SP2000PD).

**COLD START** - A momentary push-button switch to activate the system in the event no utility power is available. The system will be allowed to start up by using power from the battery. Depress this switch, the indicator above it will light, and hold it in until the audible alarm beeps once. The system will maintain a load for a period of time depending upon the condition of the battery. DC INPUT breaker must be ON.

**ALARM** - This is a fault indicator that will light in the event that the inverter generator is non-operable. This could be due to an over-temperature situation or an inverter malfunction.



**NOTE - Cold Start and Alarm Silent switches must be held in for at least two seconds to engage their function. This is to prevent any inadvertent switch operation.**

**RS232** - A DB-9 subminiature, female connector that outputs true RS232 communications signals.

**UPS OUTPUT** - A NEMA type duplex, 5-15R output connector that provides continuous power. This receptacle is connected to the bypass line when the inverter is not running.

**UPS OUTPUT CIRCUIT BREAKER** - A 15A protective circuit breaker. Protects the UPS OUTPUT 5-15R connector noted above.

**SIGNAL** - A DB-9 subminiature, female connector that outputs the open-collector signal contacts that generate a low state during *utility interrupt*, *low battery* and *inverter off* conditions.

**AC INPUT** - A six-position plug in connector provided for AC power to and from the UPS to the Bypass Box.

**DC INPUT** - A two-position connector provided for battery power to the UPS.

**RELAYS** – Six or Eight sets of normally open (NO) and normally closed (NC) contacts. These contacts are programmable thru the LCD display. See section 4.10 for instructions.

**LCD DISPLAY & PUSH BUTTONS** – An LCD Display showing UPS system data, status and settings. See section 4.

### 1.4 Summary Of Connectors – Bypass Box

Figure 2: BYPASS BOX

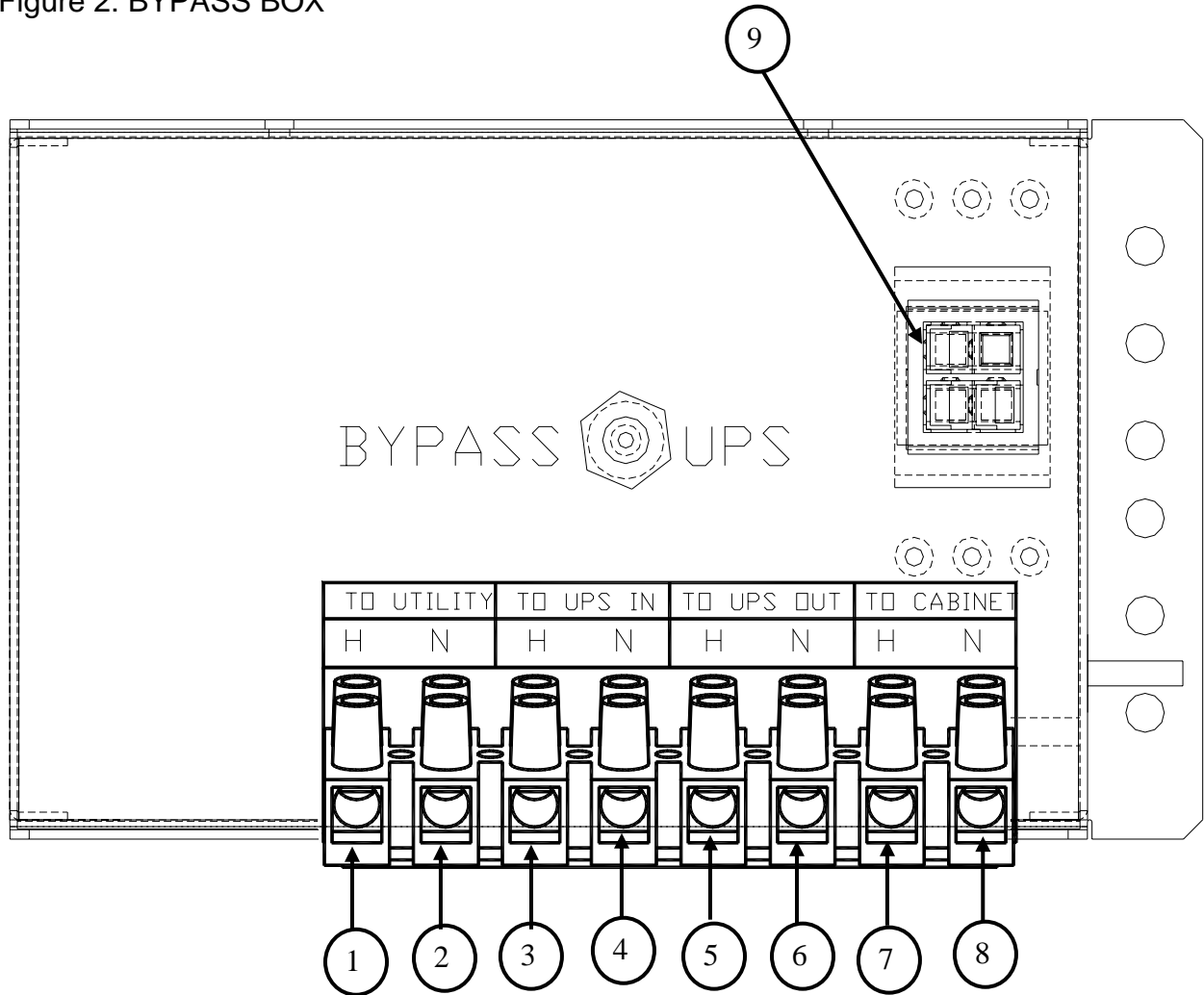

1 – To Utility - H	6 – To UPS OUT - N
2 – To Utility - N	7 – To CABINET - H
3 – To UPS IN - H	8 – To CABINET - N
4 – To UPS IN - N	9 - Generator Input (Optional)
5 – To UPS OUT - H	

Table 2: BYPASS BOX DESCRIPTIONS

Figure 3: BYPASS BOX with GFCI Option

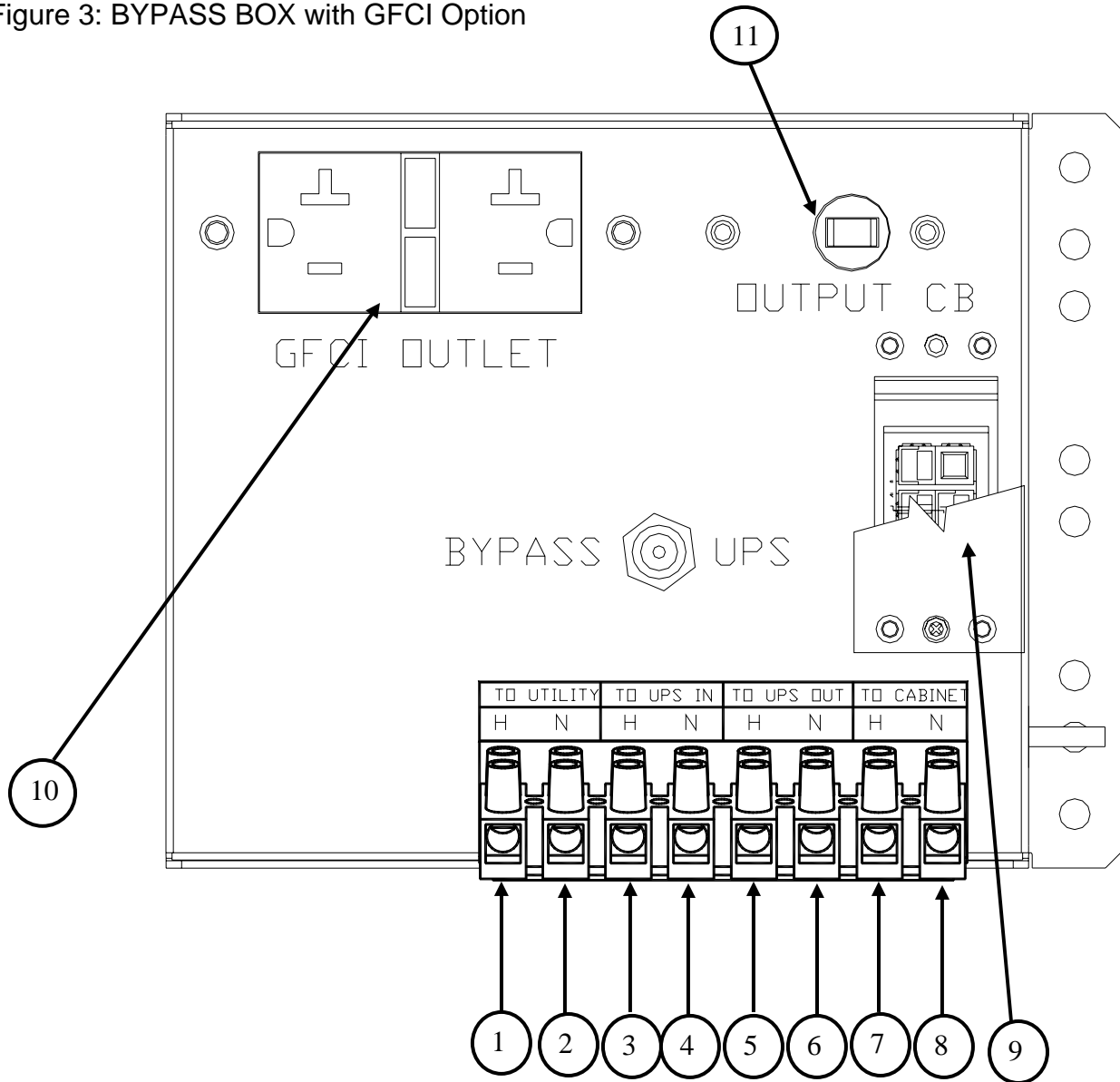

1 – To Utility - H	7 – To CABINET - H
2 – To Utility - N	8 – To CABINET - N
3 – To UPS IN - H	9 - Generator Input (Optional)
4 – To UPS IN - N	10 - GFCI Outlet (Optional)
5 – To UPS OUT - H	11 - Circuit Breaker for GFCI
6 – To UPS OUT - N	

Table 3: BYPASS BOX DESCRIPTIONS

## 2 GENERAL CHARACTERISTICS

### 2.1 Characteristics

#### Overview

The Clary *PD Series* Traffic UPS is a turnkey, true on-line, power conditioner and battery backup or uninterruptible power system (UPS) designed for the extreme environments found in traffic cabinets (-40 to + 74 deg C).

The Clary *PD Series*, with its standard 41Ahr battery pack, is capable of operating, a full LED intersection for over 2 hours at 700W (watts) output. A typical intersection consuming 450W can be powered for approximately 4 hours. In Red-Flash operation, which consume only about 300W, over 6 hours of backup is possible. These times assume fully charged batteries at the ambient temperature of 25C.

#### Operation

The Traffic UPS is capable of producing – simultaneously -- full regenerated and regulated, true sine wave power, with standby and continuous AC outputs. The Bypass Box is the link between the utility power, the UPS power, and the loads.

When utility power is adequate, the UPS routes that power to the loads. Upon loss of utility power the Traffic UPS routes UPS generated power to the loads. In the event of UPS failure and/or battery depletion, the UPS will ensure that it will drop out and return to utility power when available. The traffic control system will then default to normal operational mode.

The Bypass Box enables removal and replacement of the Traffic UPS without shutting down the traffic control system (i.e. “hot swap” capability).

For 170 type cabinets, upon loss of power the Traffic UPS can actuate the existing Flash Transfer Relays (FTRs), Mercury Contactor (MC) or Railroad Preemption to allow the traffic control system to put the cabinet into Flash Mode operation.

Existing Flasher Modules and Flash Transfer Relays are utilized. The Traffic UPS does not duplicate or take over flash operation or flash transfer relay functions.

The Traffic UPS is capable of providing continuous, fully regenerated, conditioned, regulated, sinusoidal (AC) power to selected devices such as signal controllers, counters, modems, communications hubs, NTCIP adapters, video equipment, etc.

To facilitate emergency crews and police activities, the Traffic UPS is compatible with police panel functions (i.e. “Signals OFF” switch must kill power to the field wiring even when on UPS/Battery power).

## Utility Voltage Windows and Battery Operation

The UPS operates from utility if the utility voltage is between 85 and 135 VAC. When the utility falls below 85 VAC or climbs above 135 VAC the UPS operates from the batteries. In the *Standby* modes of operation, the UPS relay is activated when the utility is below 100 +/- 2 VAC or above 130 +/-2 VAC.

There is a programmable noise rejection window, which specifies how the UPS system treats small time-duration power glitches. Power disturbances must last at least 40ms to trigger change in operation. Small disturbances on this order occur frequently due to many different conditions. These disturbances, however, are not detrimental to traffic controllers. To minimize nuisance switching this noise rejection window is implemented.

After operating in Standby mode, the UPS monitors the utility voltage. When this voltage is restored to adequate conditions for 30 seconds, the UPS returns utility power to the cabinet.

## Description

The Traffic UPS consists of three major components, the UPS Power Module, the Bypass Box, and the Battery System.

The **UPS Power Module** consists of the following:

- True on line, double conversion, pure sine wave, high frequency inverter utilizing IGBT technology.
- Programmable LCD Display.
- Two separate DB9F connectors for remote signal alarms and true RS232 monitoring and remote communications.
- Auxiliary Temp Sensor
- Multi-stage, temperature compensated battery charger.

The **Bypass Box**. A three-pole, double-throw switch that switches both hot and neutral lines to the UPS or cabinet.

The **Battery Module**. The battery is comprised of one or more strings of 6 individual 12V batteries connected in series for a total string voltage of 72V DC nominal. The SP2000PD consists of 8 individual 12V batteries connected in series for a total string voltage of 96V DC nominal.

The batteries are extreme temperature, deep cycle, AGM/VRLA (Absorbed Glass Mat/ Valve Regulated Lead Acid) batteries that have been field proven and tested by the U.S. military. The OutPost™ batteries supplied by Clary Corporation are certified to operate at extreme temperatures from -40°C to +74°C.

The batteries are provided with appropriate interconnect wiring harness. Optional battery mounting trays and brackets are available.

The interconnect cable connects to the base module via a quick-release circular connector.

The UPS module includes a charger that replenishes the Battery Pack whenever possible and required. This charger operates with a maximum charging current of 0.6A. An optional “Fast Charger” module can be installed into the UPS module to increase the charging current to over 3.5A.

### **Mounting/ Configuration**

NEMA Style: mounting method is shelf-mount or wall-mount. 170 Style: Mounting method is 19” rack-mount. Shelf angles or rails, typically supplied by others, are available as optional accessories.

Battery construction includes heavy-duty, inter-cell connections for low-impedance between cells, and heavy-duty plates to withstand shock and vibration.



## 2.2 Specifications

The various specifications of the UPS system are provided in the following tables.

Table 4: ELECTRICAL SPECIFICATIONS

<b>Electrical Specifications</b>	
Input Specification	
Nominal Input Voltage	120 VAC, Single Phase
Input Voltage Range	85 VAC to 135 VAC
Input Frequency	45 to 65 Hz (+/- 5%)
Input Configuration	3 Wire (Hot, Neutral & Ground)
Input Current (Max. draw)	8.8 amps, Power-Factor Corrected
Input Protection	Input breaker 15 amps (20 amps PD1250 (PLUS) & SP2000)
Output Specification	
Nominal Output Voltage	120 VAC, Single Phase
Power Rating	1.25 KVA (1250VA/875W), 2KVA (2000VA/1400W)
Output Voltage Regulation	+/- 2% for 100% step load change and from High battery to Low battery condition
Output Frequency	50 or 60 Hz (+/- .5%) unit not in sync.
Output Configuration	3 Wire (Hot, Neutral & Ground)
Output Wave Form	True Sine wave
Overload capability	110% for 10 minutes 200% for 50 milliseconds 2k PLUS 160% for 10 seconds
Fault clearing	Current limit and automatic shutdown
Short circuit protection	Current limit and automatic shutdown
Efficiency	90% at full load (on utility)
Load Power Factor	.7 lagging through unity to .7 leading



Table 5: Physical Specifications, UPS Electronics Module

<b>Physical Specifications, UPS Electronics Module</b>	
Dimensions:	
Width = 19", Depth = 10", Height = 6"	
Weight:	UPS: 27 lbs., Shipping weight: 33 lbs.

Table 6: PHYSICAL SPECIFICATIONS

<b>Physical Specifications, Bypass Box</b>	
Dimensions:	
Width = 7", Depth =2.5", Height =4.5"	
Weight:	BYPASS BOX: 5 lbs., Shipping weight: 5 lbs.

Table 7: ENVIRONMENTAL SPECIFICATIONS

<b>Environmental Specifications</b>	
Temperature:	- 40°C to +74°C.

Table 8: BATTERY SPECIFICATIONS

<b>Battery Specifications</b>	
Temperature:	- 40°C to +74°C.
Ampere-Hour ratings:	see Table 9
Hydrogen gas emissions:	meets Mil-Spec #MIL-B-8565J

Table 9: CLARY OutPost™ BATTERIES\*

Clary Part. No.*	Volts/ A-hrs.	Estimated Runtime (Per set @ 77°F / 25°C) (New Batteries, fully charged)				Unit Weight (Kg.)	Overall Dimensions Per Battery Inches (cm.)		
		300 Watts	500 Watts	700 Watts	875 Watts		Length L	Width W	Height H
OP72C (Set of Six Batteries)	12 VDC/ 41 AH	6.5 Hrs.**	4.0 Hrs.**	2.5 Hrs.**	1.8 Hrs.**	29 (13.2)	7.68 (19.6)	5.15 (13.1)	7.9 (20.1)

\*OP72X battery sets include six (6) batteries per set. Wired in series, each set provides 72 VDC.

\*\* Actual times may vary, runtimes are dependent on many factors.

Lower/Higher AH capacity batteries, allowing less or more runtime, are available on special order. Contact factory for more information.

**Communications, Controls & Diagnostics**

Alarm Function Monitoring: The traffic UPS comes standard with a DB-9F connector with open collectors (40 V @ 20 mA) indicating On-Battery, Low-Battery, Timeout on-battery and Alarm.

A separate RS232 Interface is provided via a DB-9F connector allowing full, interactive, remote computer monitoring and control of the UPS functions via standard UPS protocols.

Optional TCPIP/Ethernet available, contact factory for more information.

Front Panel controls: Power ON, Cold (DC) Start, Alarm Silence, Battery Test, Bypass Circuit Breaker, and DC/Battery Circuit Breaker.

**Options**

Battery Tray to hold three (3) OP72C batteries is 19" wide for use in 170 type cabinets and mounts on standard RETMA rails.

Swing-out Battery Box, mounts on right rail inside back door of 170 type cabinets. Box is designed to hold tree (3) OP72C batteries

Fast Battery Module, optional module provides extra charging current to the batteries when required, reducing charging time. (SPD-14C2, (SPD-14C3 FOR 2000VA SYSTEMS))

External Temperature Sensor (SPD-16H1)

## 3 INSTALLATION AND OPERATIONS

### 3.1 Installation

The UPS system is typically rack or shelf mounted in standard traffic cabinets. When determining how to position the UPS system inside your cabinet, the following requirements **MUST** be met.

- The installation site **MUST** maintain an ambient air temperature of less than 165°F (74°C).
- The air inlets, vents and fan **MUST NOT** be obstructed or blocked in any way. There **MUST BE** clearance around each air-inlet and vent.
- The air should remain free from excessive dust and chemical fumes.
- Total power requirements to be drawn from the UPS must not exceed the rated power of the UPS.

Please note these items when designing the UPS system's mounting hardware:

- The front panel is designed to fit in a standard 19" rack. This panel fills a 6-inch slot.

### 3.2 Preparation

Installation of the PD Series Traffic UPS must be preceded by careful preparation. The following steps are typical:

- Ensure that the Installation Requirements will be met. (See previous section).
- Read this manual thoroughly.
- Assemble wiring diagrams.

- Unpack and ensure that all UPS System components are on-hand and operative:
  - UPS System Module
  - (Bypass Box)
  - Battery Module (6 batteries w/cabling)
- Collect appropriate mounting hardware for the particular installation.
  - For 170/332 cabinets only, one or two battery trays (per shipping documents, depends on version purchased)
- Assemble your tools and inventory your equipment. Table 10 is a checklist of items that have proved useful during previous installations.
- Contact the responsible agencies to schedule a brief power down (10 to 15 minutes) at the intersection(s) affected.
- Allot 2 hours of time for the installation.

Table 10: RECOMMENDED INSTALLATION EQUIPMENT

Armored sheathing (cable protector)	Connectors (butt type and insulated)
Cordless drill w/ bits and a spare battery pack	Crimpers (for insulated and non-insulated connectors)
Dikes	DVM w/ probes
Electrical Tape	Flat Head screwdriver
Hardware in spill-proof carrying case	Hold-downs (adhesive back)
Nut Driver Set	#2 Phillips head screwdriver
Phillips head drill bit	Propane torch (miniature) or cigarette lighter
Shrink tubing	Socket Set
Socket Wrench	Current clamp meter
Wire cutters	Wire strippers

### 3.3 Procedure

The recommended installation procedure is presented in Table 11 . The Table refers to, which presents a schematic wiring diagram.

Read through the entire procedure before beginning. If any steps are unclear, do not begin the installation process – please contact Clary Corporation for assistance.

Finish each step completely before continuing to the next.

See Figure 4 for diagram.

Table 11: TYPICAL INSTALLATION PROCEDURE FOR TRAFFIC UPS

1. Mount Bypass Box and position switch to Bypass.
2. Disconnect utility input H from input terminal block in cabinet and connect to Bypass Box (To Utility H).
3. Disconnect utility input N from input terminal block in cabinet and connect to Bypass Box (To Utility N).
4. Connect AWG #10 black wire from Bypass Box (To Cabinet H) to input terminal block (H) in the cabinet.
5. Connect AWG #10 white wire from Bypass Box (To Cabinet N) to input terminal block (N) in the cabinet.
6. Connect the AWG #10 green wire from the provided cable assembly to the ground bus terminal in the cabinet.
7. Mount UPS in cabinet and make sure system switch is in the “OFF” position.
8. Mount Batteries and connect all interconnect connectors from the battery cable.
9. Connect Cable from the Bypass Box to the UPS.
10. Connect battery cable to UPS. Make sure the six or eight batteries are wired in series (+ to -) with 72VDC or 96VDC full potential across complete string.
11. Connect Flash connections to the UPS.
12. Test installation for proper operation.
13. Document installation.

### 3.4 Operating Configuration and Setup:

Figure 3 shows how the UPS System is connected to the traffic cabinet. This schematic diagram illustrates the interconnections.

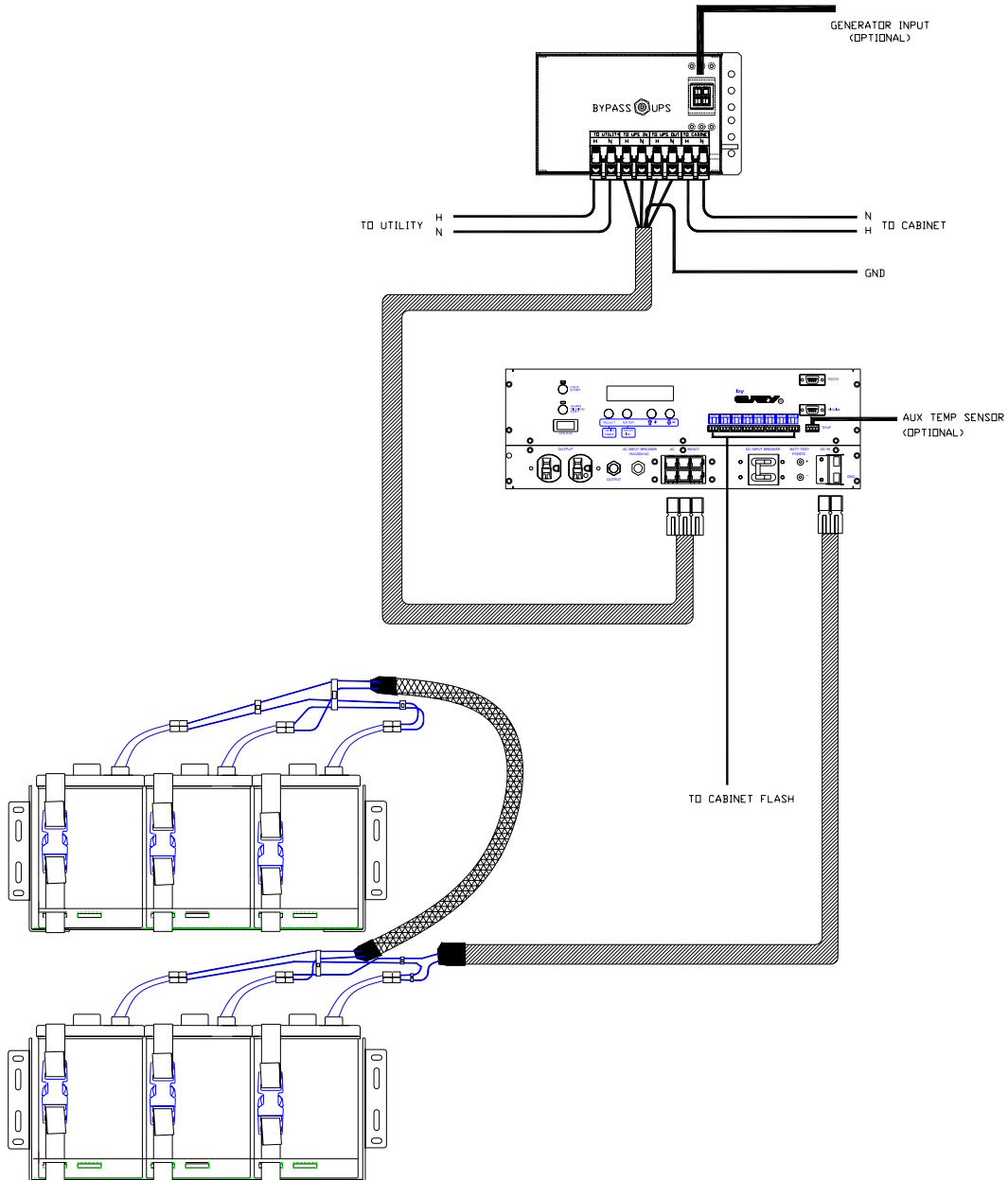

Figure 4: UPS TO CABINET INTERCONNECTIONS

### 3.5 Start-up

Once the system has been properly installed, it is ready to operate. The following procedures will explain how to start-up the system while wired into rated electrical power and also how to start-up with no AC power available.

#### Normal Operation on AC Start-Up:

- Verify that the unit is wired into properly rated electrical power through the Bypass Box.
- The AC IN and DC IN cables must be fully connected to the unit. Position the DC breaker to the **ON** position.
- Position the System Power Switch to the **ON** position.

After switching ON, the UPS performs a self-test and the display will show:

CLARY CORPORATION mm/dd/yy    hh:mm:ss
---

After completion of the self-test, the display will show the default screen (values are examples).

LOAD 50%    BATT 100% AC LINE OK,    INV ON
--

- **Battery Operation after AC Start-Up:**

When Utility power is lost, the Alarm LED will blink and the display will show: (values are examples)

LOAD 50%    BATT 90% AC LINE BAD,    INV ON
--

In **stand-by mode**, inverter power will be supplied to the cabinet in two timing steps to control the traffic equipment wired to the PD system, now powering the cabinet in *flash* mode. In **continuous mode**, the cabinet operation will continue without interruption.

If the unit is allowed to operate until batteries are exhausted, it will time out and shut off completely. If power were to return, the unit will automatically restart and return to the condition it was in at the moment it went into *Battery Mode*.

Once power is returned, if in **standby mode**, inverter power to the traffic equipment will be discontinued through the UPS in a sequenced timing operation. The UPS will keep the the intersection in flash for 30 seconds to ensure Utility power is stable. In **continuous mode**, the cabinet operation will continue to operate without interruption.

#### DC Start Operation (Cold Start)

If no utility power is available at the time backup power is required, the unit may be started to accomplish abbreviated tasks. The limitations of the battery prevent extended operations at full load.

- Position the DC Input Breaker to the **ON** position.
- Position the System Power Switch to the **ON** position.
- Push and hold in the COLD START switch until the audible alarm beeps.



The unit will start up similarly to normal AC start-up except the Alarm LED will continue to blink. It will now operate as described above in battery operation.

### **3.6 Optional Communication Procedure**

The UPS system includes additional interfaces for communications to host computers or other similar devices. Their use is optional, but allows for remote monitoring and control of the power system. Effective utilization of these capabilities will enhance the reliability of the traffic power system.

There are two DB-9, subminiature, female connectors. These are provided for communications links to a computer or sophisticated monitoring device. These two connectors are labeled and used as:

- SIGNAL provides open collector type contact closures that signal *AC Input Fail/Timer, Low Battery* and *UPS ON* conditions.
- RS232 is a true communications signal port. This port connects to standard PC-type serial ports.

See Figure 4 for Pin assignments.

**SIGNAL PORT**

- 2- AC INPUT FAIL/FLASH TIMER
- 3- UPS ON
- 4- COMMON SIGNAL RETURN
- 5- LOW BATTERY
- 6- +9VDC
- 8- +9VDC

**RS232 PORT**

- 1- LOW BATTERY
- 2- TX
- 3- RX
- 4- RS232 SHUTDOWN
- 5- GROUND
- 6- +9V
- 8- AC FAIL

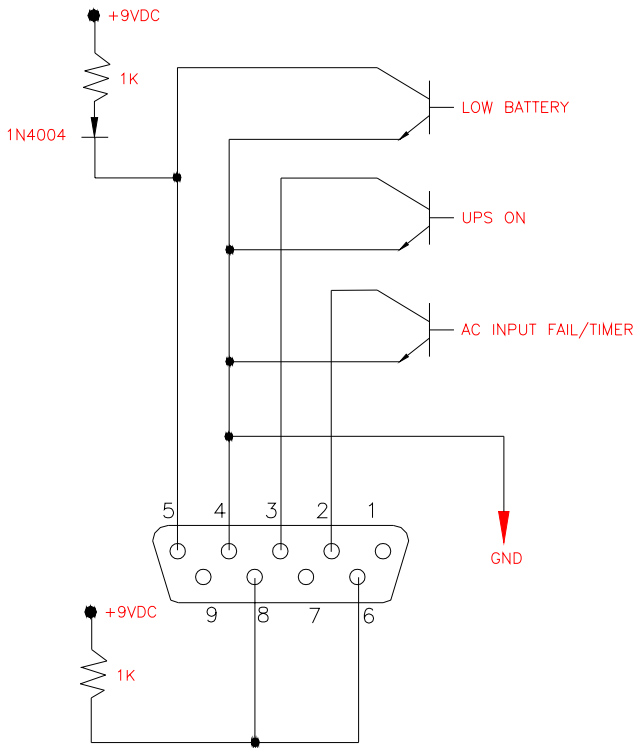

**SIGNAL: DB-9**  
**CONNECTOR**

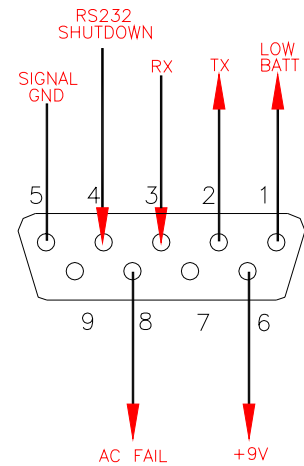

**RS232: DB-9**  
**CONNECTOR**

Figure 5: SIGNAL/RS232 PIN ASSIGNMENTS

## 4 PROGRAMMABLE LCD DISPLAY

### 4.1 Introduction

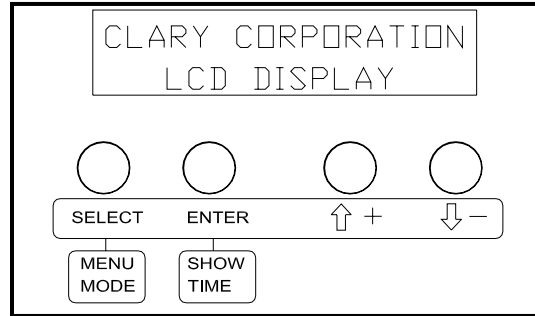

The LCD display on the UPS front panel is used to show various operational parameters of the UPS (in real time) as well as other important system information. It is also used to program options and set points for many UPS functions.

The LCD display operates in two main modes:

1. Normal Mode - The default mode of operation for displaying real time UPS parameters. When left unattended, the display will always revert back to normal mode.
2. Menu Mode - Used for accessing additional system information and for programming any modifiable UPS parameters. Menu mode is accessed by pressing and holding the Select/Menu Mode button for approximately two seconds.

The Programmable LCD Display is operated by the 4 push button switches. Once in Menu mode, the following eight main menus can be selected:

1. Battery system status
2. Power system
3. UPS system
4. UPS info
5. Event log
6. Options
7. Time/Date
8. Relays

From the normal mode's main screen, depress and hold the SELECT/MENU MODE button until Menu mode is entered (The screen will change to the Battery System status screen). Press the SELECT/MENU MODE button to go to the menu you want then press ENTER. You will now be in one of the seven menus.

## 4.2 Normal Mode

The Normal mode's main screen shows the Load and Battery percentage, AC input status and Inverter status. The Normal mode display will look something like the following.

```
LOAD 50%  BATT 90%  
AC LINE BAD,  INV ON
```

To see the time and date, press the ENTER/SHOW TIME button.

```
LOAD 50%  BATT 90%  
mm/dd/yy  hh:mm:ss
```

## 4.3 Battery System Status

```
STATUS: BATTERY Syst
```

Once at this screen, press the ENTER/SHOW TIME button. Then press the SELECT/MENU MODE button to go through the Battery System Status menu.

```
St20: Battery Status  
78V => BAT is FULL
```

Shows Battery status and Voltage

```
St21: Bat Condition  
Battery is GOOD!
```

Shows condition of the Batteries.

```
St22: Battery Usage  
15 HOUR 10 MIN
```

Shows total time in hrs that UPS was running off of Battery Power.

To Clear usage, press and hold both the UP and Down Arrow buttons simultaneously until the time clears.

St23: BACKUP Events  
2 Events

Shows number of times UPS went to Battery Power.

To clear events, press and hold both the UP and Down Arrow buttons simultaneously until the event count clears.

St24: Battery Type  
72 Volts 41 Ahr

Shows the nominal battery voltage and the battery Amp hours.

St25: Battery Ahr  
ALTER> Ahr = 41

This screen allows the user to enter the Battery Capacity within the range of 10Ahr to 150Ahr.

To change Ahr rating, Press Enter. Press the Arrow buttons until the desired rating is displayed. Press Enter to keep this change.

St26: Estim Bat Time  
10 minutes

Shows estimated time remaining when UPS is running on Battery Power.

St27: Batt Inst Date  
mm/dd/yyyy

Shows Battery installation date. Can only be set to the current date. To reset, press and hold both the UP and Down Arrow buttons simultaneously until it resets to the current date.

#### **4.4 Power System Status**

STATUS: POWER System

Once at this screen, press the ENTER/SHOW TIME button. Then press the SELECT/MENU MODE button to go through the Battery System Status menu.

St30: Input Line Pwr  
115Vrms 60Hz 1.5A

Shows the Input line power Voltage, Frequency and Current going into the UPS.

St31: Output Pwr Src  
UTILITY

Shows the power source which the UPS is currently running off of (UTILITY or BATTERY).

St32: Output Pwr/Ld  
120Vrms 60Hz 50%

Shows the Output Voltage, Frequency and Load percentage.

## 4.5 UPS System Status

STATUS: UPS SYSTEM

Once at this screen, press the ENTER/SHOW TIME button. Then press the SELECT/MENU MODE button to go through the Battery System Status menu.

St40: Operating Mode  
NORMAL

Shows the operating status of the UPS (NORMAL, BACKUP,.....etc).

St41: Alarm Status  
1 ALARM

Shows the Alarm status and number of alarms which are currently active (OVERTEMP, OVERLOAD, OUTPUT BAD, INPUT IS BAD.....etc).

St42: Temperature  
Loc 25C Rem 25C

Shows the local and remote temperature in degrees Celsius. Remote temperature readings are available only when an auxiliary temperature sensor is installed.

St43: Shutdown Stat  
NO SHUTDOWN PENDING

Shows shutdown status of UPS.

St44: POWERDOWN Stat  
f\_code: 00 BATDEAD

Shows the reason the UPS shutdown previously with an associated error code.

St45: INITIALIZE ALL  
PARAMS but TIME/DATE

Press and hold both arrow buttons to initialize. This will set all settings except for the date and time back to the factory default.

St46: INITIALIZE ALL  
LCD PANEL PARAMETERS

Press and hold both arrow buttons to initialize. This will set all settings to the default.

## 4.6 UPS Information

Status:          UPS Info
---------------------------

Once at this screen, press the ENTER/SHOW TIME button. Then press the SELECT/MENU MODE button to go through the UPS Information menu.

St50: UPS Base Model # SP1250I
-----------------------------------

Shows UPS Base Model#

St51: UPS User Model My Model #
------------------------------------

Shows the model of the UPS.

To change the model #, Press the enter key. Hold down the Enter, Up Arrow and Down Arrow until display clears. Use the arrow keys to increment to the character you want. Press Enter to go to the next position.

St52: UPS Pwr Rating 1250VA
--------------------------------

Shows UPS power rating in VA.

St53: UPS Firmware 86501-35.301
------------------------------------

Shows the type and revision of the UPS firmware(EPROM) installed in the unit.

St54: LCD Firmware DEV 12-20-2007 REV-A
--

Shows the type and revision of the firmware installed in the LCD Display. Screen shown is just an example.



## 4.7 Event Log

Status: EVENT LOG's

Displays a history of the most recent 100 logged events. Once at this screen, press the ENTER/SHOW TIME button. Then press the SELECT/MENU MODE button to go to the logs.

LOG# 100 AC FAIL  
mm/dd/yy hh/mm/ss

Use the Arrow Keys to scroll through the logs. Press and hold both the up and down arrow keys simultaneously to clear all the event logs.

## 4.8 Options

Status: OPTION's

Displays the current system option values and allows selected options to be modified. Once at this screen, press the ENTER/SHOW TIME button. Then press the SELECT/MENU MODE button to go through the options menu.

INTERFACE DELAY  
current value = 2

Not used. For future use.

FLASH TRIGGER (MINS)  
current value = 120

This is the time in minutes that specifies the trip point that activates the Timer open collector signal on the **Signal port**. Make sure you have changed the Flash Status Pin to "ON" to activate this feature. To Change the value, press the arrow buttons. Once at the desired value, press the Enter/Show Time button to save. The screen will now show the new value. Default is 120.

FLASH TRIGGER (VOLT)  
current value = 69

This is the battery voltage that specifies the trip point that activates the Low Battery open collector signal on the **Signal port**. To Change the value, press the arrow buttons. Once at the desired value, press the Enter/Show Time button to save. The screen will now show the new value. Default is 69.

BATTERY TEST (HOURS)  
current value = 160

This will set the Battery Test Interval. The unit will perform a battery self test to determine the condition of the battery. To Change the value, press the arrow buttons. Once at the desired value, press the Enter/Show Time button to save. The screen will now show the new value. Default is 160.

CALIB PARAMETER #9  
current value = 0

This calibration parameter sets the low point at which the UPS switches over to UPS Power. Used when unit is set in the standby mode. Flash contacts will activate. **It is Not recommended to change this parameter unless instructed to do so by the factory.**

CALIB PARAMETER #10  
current value = 0

This calibration parameter sets the high point at which the UPS switches over to UPS Power. Used when unit is set in the standby mode. Flash contacts will activate. **It is Not recommended to change this parameter unless instructed to do so by the factory.**

TRAFFIC ONLINE OPER  
current value = ON

This screen will allow you to operate the unit "ONLINE" (Continuous Operating Mode) or "OFFLINE" (Standby Mode). To Change the value, press the arrow buttons. Once at the desired value, press the Enter/Show Time button to save. **Be sure your load is not over the max rating of the unit before turning the UPS ONLINE.**

LONG RETURN ALWAYS  
current value = OFF

This option is used in the “Standby Mode”. When “ON”, the UPS will force a break in power to the cabinet for 2.5 seconds after utility power has returned. This is used when you need a hard restart to the controller when coming out of flash. To Change the value, press the arrow buttons. Once at the desired value, press the Enter/Show Time button to save.

LONG RETURN FLASH  
current value = OFF

This option is used in the “Continuous Operating Mode” when delayed flash is used. When “ON”, the UPS will force a break in power to the cabinet for 2.5 seconds after utility power has returned if flash trigger in minutes or volts occurs. This is used when you need a hard restart to the controller when coming out of flash. To Change the value, press the arrow buttons. Once at the desired value, press the Enter/Show Time button to save.

FLASH STATUS PIN  
current value = OFF

This enables the flash trigger in minutes option. The AC input fail/Timer open collector on the **Signal Port** will activate off the Timer. To Change the value, press the arrow buttons. Once at the desired value, press the Enter/Show Time button to save.

UTILITY STATUS PIN  
current value = ON

This enables the AC input fail/Timer open collector on the **Signal Port** to activate whenever utility power is lost.

By changing the Flash Status Pin value, the Utility Status Pin value will change to the opposite value. To Change the value, press the arrow button. Once at the desired value, press the Enter/Show Time button to save.

BROWNOUT PROTECTION  
current value = ON

This feature is used only in the standby mode. The brownout protection feature allows the UPS to switch to inverter power from utility power to the cabinet without running off of batteries when utility power is experiencing certain brownout conditions. When the input voltage falls below 100VAC  $\pm 2V$  or rises above 130VAC  $\pm 2V$ , the UPS switches over to inverter power but is still running off of the utility power. As soon as the utility voltage falls below 88VAC  $\pm 2V$  or rises above 135VAC  $\pm 2V$ , the UPS then begins to run off of battery power. This ensures that the cabinet will see no less than 100VAC or more than 130VAC and the UPS will not use battery power if the utility voltage drops in this window.

FAILURE STATUS DELAY  
current value = OFF

Sets a 10 second delay in the utility fail signal.

AUDIBLE ALARMS <<\*>>  
current value = OFF

This screen allows you to enable and disable the audible alarm. To Change the value, press the arrow buttons. Once at the desired value, press the Enter/Show Time button to save. Default is OFF.

SYNC VGEN TO VAC  
current value = ON

This screen allows you to enable/disable the sync of the UPS output. To change the value, press the arrow button. Once at the desired value, press the Enter/Show Time button to save. Default is ON.

## 4.9 Time and Date

Status: TIME/DATE

This screen allows you to set the time and date. Once at this screen, press the ENTER/SHOW TIME button.

display TIME & DATE

Press the Select/Menu Mode button to go to the time or date that you want to change. You can set hours, minutes, seconds, day of week, month, year and day of month.

Once you are at the screen that you want, press the Enter/Show Time button. Use the Arrow buttons to select the value that you want. Press the Enter/Show Time button to save.

## 4.10 Relays

Status:	RELAY's
---------	---------

Once at this screen, press the ENTER/SHOW TIME button. Then press the SELECT/MENU MODE button to go through the three main Relay menus.

### 4.10.1 ASSIGN RULE TO RELAY

*SEE TABLES 12 & 13 FOR DETAILED RULE DESCRIPTIONS AND ALARMS/FAULTS.*

ASSIGN RULE to RELAY
----------------------

This menu allows you to select a "Rule" for each of the eight relays. Once at this screen, press the ENTER/SHOW TIME button. To scroll thru the eight relays, press the SELECT/MENU MODE button.

RELAY #1 IS USING: RULE 01: ON_BAT
---------------------------------------

Once at the relay that you want to change, press the ENTER/SHOW TIME button. You can then change the "Rule" of this relay by pressing the arrow buttons. When finished press the ENTER/SHOW TIME button. If you want to change another Relay, press the SELECT/MENU MODE button to go to the next desired relay.

Note: You can set all the Relays back to the default factory settings by holding both the arrow keys down simultaneously until the screen says "Defaults are now set". You can do this anytime you are in the "Assign Rule to Relay" menu. **All eight relays will return to their default settings(See table 14).**

#### 4.10.2 MODIFY RULE PARAMETERS

MODIFY RULE PARAM's

This menu allows you to change the parameters of each rule. Once at this screen, press the ENTER/SHOW TIME button. To scroll thru the sixteen "Rules", press the SELECT/MENU MODE button.

RULE 02: LOW\_BAT\_1  
New TRIP PT = 40%

Once at the desired "Rule", press the arrow buttons to set new value for the "Rule". When finished, press the ENTER/SHOW TIME button. If you want to change another "Rule", press the SELECT/MENU MODE button to go to the next desired "Rule".

Note: You can set all the "Rules" back to the default factory settings by holding both the arrow keys down simultaneously until the screen says "Defaults are now set". You can do this anytime you are in the "Modify Rule Parameters" menu. **All sixteen "Rules" will return to their default settings(See table 14).**

### 4.10.3 TOGGLE RELAY ON/OFF

TOGGLE RELAY ON/OFF

This menu allows you to manually control the Relays. Once at this screen, press the ENTER/SHOW TIME button. To scroll thru the eight relays, press the SELECT/MENU MODE button.

STATE of MANUAL MODE  
Current state = OFF

When the Relay's Manual mode is off, the current state of each relay can only be read but may not be changed. To manually change the state of a relay, Manual mode must be first activated.

Note: Once Manual mode is active, the relay rules which normally control the relays will be ignored (until Manual mode is again deactivated or power is cycled).

To toggle Manual mode ON/OFF, go to this screen to set the state of the relays to manual mode. Once at this screen, press the arrow buttons to change the state from ON/OFF. After selected, press the ENTER/SHOW TIME button. Press the SELECT/MENU MODE button to scroll thru the eight relays.

STATE of RELAY #1  
Current state = OFF

Once at the desired relay screen, press the arrow buttons to select ON/OFF for that relay. Press the ENTER/SHOWTIME button to select. Relay will now change states.

Table 12: LIST OF RULES

#	Rule	Description	Parameters
00	Relay Off	Turns Relay OFF.	None
01	On_Bat	Activates when UPS is on Battery Mode.	None (Use Rule#16 if you are using UPS in the Offline(Standby) Mode to Cabinet Flash.)
02	Low_Bat_1	Activates when batteries reach user settable capacity level.	Set battery capacity in % Limits 0% - 100%, Resolution 1%
03	Bat_Timer_1	Activates after user settable time when UPS is in Battery mode.	Set Timer in HH:MM:SS Limits 00:00:00 – 18:12:15, Resolution 1 Second
04	Alarms_1	Activates when Alarm conditions occur.	See Alarm/Fault Table Allows you to choose which alarms you want to activate this condition. You may choose all or just some.
05	Faults_1	Activates when Fault conditions occur.	See Alarm/Fault Table
06	Low_Bat_2	Additional Low_Bat condition. Functions same as Low_Bat_1.	Set battery capacity in % Limits 0% - 100%, Resolution 1%
07	Bat_Timer_2	Additional Bat_Timer condition. Functions same as Bat_Timer_1.	Set Timer in HH:MM:SS Limits 00:00:00 – 18:12:15, Resolution 1 Second
08	Alarms_2	Additional Alarm condition. Functions same as Alarms_1.	See Alarm/Fault Table
09	Faults_2	Additional Fault condition. Functions same as Faults_1.	See Alarm/Fault Table
10	Low_Bat_3	Additional Low_Bat condition. Functions same as Low_Bat_1.	Set battery capacity in % Limits 0% - 100%, Resolution 1%
11	Bat_Timer_3	Additional Bat_Timer condition. Functions same as Bat_Timer_1.	Set Timer in HH:MM:SS Limits 00:00:00 – 18:12:15, Resolution 1 Second
12	Alarms_3	Additional Alarm condition. Functions same as Alarms_1.	See Alarm/Fault Table
13	Faults_3	Additional Fault condition. Functions same as Faults_1.	See Alarm/Fault Table
14	Fan_Ctrl_1	Activates at Temperature levels set by user.	Set Hi/Lo limits. Choose from internal sensor or external(Aux) sensor. There is a minimum Five°C differential limit between the HI and Low limits. Limits 0°C - 125°C, Resolution 1°C
15	Fan_Ctrl_2	Additional Fan Control condition.	Set Hi/Lo limits. Choose from internal sensor or external(Aux) sensor. There is a minimum Five°C differential limit between the HI and Low limits. Limits 0°C - 125°C, Resolution 1°C
16	UTILFAIL_IM	Activates immediately when UPS goes to battery mode.	None (Used to activate Flash when in the Offline(Standby) Mode)



Table 13: ALARMS AND FAULTS

Alarms/Faults	Description
Heat Sink is Hot	Heat Sink on main Board temperature too high.
Input is bad	AC input to UPS is not within limits.
Output Strange	Bad UPS output.
System Overload	Load is higher than UPS rated load.
Bypass Failure	Bypass Line failed.
Charger Failure	Charger not functioning properly.
Fan Fail	Fan not functioning properly.
Fuse Failure	Open Fuse in system.
Sleep Alarm	UPS in sleep mode.
General Fault	UPS component failure.
All Outputs Off	Output not present.
Shut Off Pending	A shutdown command has been activated.
Shut Off Imminent	UPS is preparing to shutdown.
System Shutdown	UPS system switch turned Off.

Table 14: DEFAULT SETTINGS

Relay to Rule		Rule's Parameters	
Relay	Rule	Rule	Parameters
1	01-On_Batt	02-Low_Bat_1	40%
2	02-Low_Bat_1	03-Bat_Timer_1	02:00:00
3	02-Low_Bat_1	04-Alarms_1	All enabled
4	03-Batt_Timer_1	05-Faults_1	All enabled
5	03-Batt_Timer_1	06-Low_Bat_2	50%
6	04-Alarms_1	07-Bat_Timer_2	01:23:45
7	14-Fan_Ctrl_1	08-Alarms_2	All enabled
8	00-Relay Off	09-Faults_2	All enabled
		10-Low_Bat_3	60%
		11-Bat_Timer_3	01:01:01
		12-Alarms_3	All enabled
		13-Faults_3	All enabled
		14-Fan_Ctrl_1	27/21
		15-Fan_Ctrl_2	27/21

## 5 CARE AND MAINTENANCE

### 5.1 Safety

There are hazardous high voltages and materials present in the UPS system which present safety risks. You **MUST** follow basic safety procedures when maintaining the UPS. In addition please note the following:

#### ELECTRICAL SAFETY



- Hazardous high voltages are present in this product, which can cause electrical shock.
- Do not work alone under hazardous conditions.
- Always wear eye-protection when servicing energized power electronics.
- Connect equipment only to three wire AC outlets (two poles plus ground). The receptacle must be connected to an appropriate protected branch circuit (fuse or circuit breaker).
- Connecting this equipment in a manner other than specified may result in a shock hazard and may violate local electrical codes.

#### DE-ENERGIZING SAFETY

- To de-energize the UPS, BOTH the AC Power connector and the DC Power connectors must be disconnected.
- There is internal energy storage in the UPS Power Module. This energy is stored in Capacitors, which require at least 2 minutes of discharge time after power is disconnected.

## 5.2 Preventive Maintenance

### CLEANING

This device is designed to be maintenance-free. It can be cleaned with a damp cloth or nonabrasive cleanser.

**WARNING:** Do not use ACETONE-BASE cleaning solutions. Keep cleaning solutions out of the electrical receptacles on this device.

Be sure filters, vents and fans are kept free from accumulation of dust, dirt or lint. Below (see Table 15) is a simple maintenance schedule that will assist you in keeping the system at its peak level of performance and also minimizing potential premature failures.

### BATTERIES

Your system contains sealed maintenance-free batteries. When situated in the proper environment, with the proper charging and limited cycling, these batteries can last many years.

Battery replacement should be performed or supervised by personnel familiar with the dangers of batteries and the required precautions. DO NOT permit untrained or unauthorized personnel to replace or service batteries.

**WARNING:** Never attempt to service batteries. Servicing of batteries should be performed or supervised by personnel knowledgeable of batteries and the required precautions. Keep unauthorized personnel away from batteries. When replacing batteries, use the same number and type batteries.

**CAUTION:** Do not dispose of battery or batteries in a fire. The battery may explode.

**CAUTION:** Do not open or mutilate the battery or batteries. Released electrolyte is harmful to the skin and eyes. It may be toxic.

**CAUTION:** A battery can present a risk of electrical shock and high short circuit current. The following precautions should be observed when working on batteries:

1. Remove watches, rings, or other metal objects.
2. Use tools with insulated handles.
3. Wear rubber gloves and boots.
4. Do not lay tools or metal parts on top of batteries.
5. Disconnect the charging source prior to connecting or disconnecting battery terminals.
6. Determine if the battery is inadvertently grounded. If inadvertently grounded, remove source of ground. Contact with any part of a grounded battery can result in electrical shock. The likelihood of such shock will be reduced if such grounds are removed during installation and maintenance.
7. The rechargeable battery is recyclable. At the end of its useful life, under various state and local laws, it may be illegal to dispose of this battery into the municipal waste stream. Check with the factory for details in your area for recycling options or proper disposal.

### BATTERY RECYCLING



- The batteries used in this equipment are recyclable. Proper disposal is required and mandated by law. The batteries contain lead and pose a hazard to the environment and human health if not disposed of properly.
- Refer to local codes for proper disposal requirements or return the batteries to the factory.
- ALWAYS contact the factory for information concerning shipment, disposal, or replacement of batteries.

Table 15: PREVENTIVE MAINTENANCE SCHEDULE

Item	Schedule	Actions
Cleaning	6 Mos.	Blow out unit with air.
Battery	6 Mos.	Clean terminals and check for corrosion.
Fans	6 Mos.	Check for proper operation.

### 5.3 Trouble Analysis

Unit does not power up:

- Make sure AC & DC input connectors are connected and seated properly.
- Check front panel fuse(F1)
- Check Bypass Box for proper installation and wiring.
- Check Bypass Box to be switched to the “UPS” position.

No Backup when utility power is lost:

- Make sure DC breaker is in the “ON” position.
- If Bypass switch is installed, make sure it is in the “UPS” position.
- Check Batteries.

Front Panel Fuse(F1) keeps going bad:

- Possible bad inverter.

On turn on, Unit goes through startup sequence then goes into alarm and inverter does not turn on:

- Possible bad inverter.
- Load on unit may be over Max. rating.

Unit in Alarm, but is still operating OK:

- Possible over temp.
- Check fans in the unit to make sure they are running.

In On-line operation, intersection goes into flash when utility power is loss:

- Check UPS for proper installation and wiring.
- Options in the program may not be set properly.

## **5.4 Service and Repair**

Your **PD Series** UPS is backed by one of the finest customer service teams available. Write or call them at any time to obtain more information about your unit.

**Clary Corporation**  
**150 E. Huntington Drive**  
**Monrovia, CA 91016**  
**1-800-551-6111**

If a problem should occur, it is important that you obtain a Return Material Authorization (RMA) number from the Service Department to process any unit returned to the factory. In consulting the factory, always have the unit model number and serial number at hand. This information is located on the identification label and is essential in retrieving your unit's performance and history record.

The RMA number issued to you should appear on the outside of the carton, if the unit is returned, or on any correspondence regarding your unit. When shipping a unit back to the factory, try to use the original packing container and shipping materials. The Service Department cannot take responsibility for any unit damaged in return shipment. All units must be returned prepaid to:

**Clary Corporation**  
**Service Department**  
**150 E. Huntington Drive**  
**Monrovia, CA 91016**

## **6 SCHEMATICS**

## WARRANTY

1. **TIME AND SCOPE OF WARRANTY:**
  - 1.1. Clary Corporation hereby warrants parts shipped under this Agreement to be free from defective workmanship for a period of 2 years following date of shipment. Accidental damage, misuse or normal wear and tear shall not be construed as a defect.
  - 1.2. The date of shipment as used herein will be the date on the Bill of Lading. If no Bill of Lading is issued the date of shipment shall be shown on seller's shipping document.
  - 1.3. No provision of this warranty shall cover equipment that has been altered or modified from the original specifications to which it was manufactured unless authorized in writing.
  - 1.4. No provision of this warranty shall cover batteries. However, battery manufacturer's warranties will be passed through to the customer whenever applicable.
2. **LIMITS OF "IN WARRANTY" SERVICE LIABILITY:**
  - 2.1. Clary is obligated during the in-warranty period to provide service and/or adjustments to equipment returned to the factory at the expense of buyer (the term "factory" as used here-in shall also include any field service centers which may be established by Clary) and to repair or replace any part(s) thereof which in the opinion of authorized Clary personnel are found to have been defective.
  - 2.2. Equipment requiring in-warranty services must be returned to the factory with all transportation charges prepaid, clearly tagged, and stating the nature of the trouble experienced, and the disposition of the equipment after repair. The equipment will be returned collect by Clary to the location specified via the best, least expensive carrier available or via customer's shipping instructions.
  - 2.3. The nature of certain equipment installations may be such that it would be impractical or technically infeasible to remove the Clary portion of the equipment from the customer's premises to the Clary factory. In such cases, and at the request of the buyer, Clary will perform such service as can be satisfactorily rendered at buyer's location. The buyer will be charged only for travel expenses incidental to the service call, provided that the warranty is applicable.
  - 2.4. During the in-warranty period, no service charges shall be payable by the buyer for service performed other than for service necessitated by accident, misuse, theft, abnormal line or source voltage fluctuations, abnormal conditions of operation, damage by the elements or damage resulting from adjustments, repairs, modifications made by other than Clary Authorized personnel, or the buyer's failure to reasonably maintain the equipment.
  - 2.5. **THE FOREGOING WARRANTY IS EXCLUSIVE AND IS GIVEN AND ACCEPTED IN LIEU OF ANY AND ALL OTHER WARRANTIES, EXPRESSED OR IMPLIED, INCLUDING WITHOUT LIMITATION THE IMPLIED WARRANTIES OF MERCHANTABILITY AND FITNESS FOR A PARTICULAR PURPOSE. THE REMEDIES OF BUYER SHALL BE LIMITED TO THOSE PROVIDED HEREIN. IN NO EVENT WILL SELLER BE LIABLE FOR COLLATERAL OR CONSEQUENTIAL DAMAGES.** No person is authorized to assume in behalf of Clary any obligation or liability in connection with the sale, warranty or service policy of any products manufactured and/or marketed by Clary Corporation beyond the warranty description on the face hereof.
3. **Clary Corporation reserves the right to make changes, additions, and/or improvements in its products without incurring any obligation to install them on its products previously sold.**